

Data Sheet for Precision Potentiometer

Multiturn Wirewound Potentiometer

Series 46HDS



The potentiometers of the series 46HDS are used as multiturn sensors with outstanding linearity and resolution for measuring ranges from 3 to 20 turns.

- Multiturn from 3 up to 20 turns
- Optional limit switch (CW, CCW)
- Optional back shaft
- Power rating up to 10 W
- Optional tandem version

The optionally integrable limit switches can be factory-configured within the electrically effective angle of rotation or within the signal plateau.

Electrical Data	3-turn	5-turn	10-turn	15-turn	20-turn
Effective electrical angle of rotation 1.)	1080° ±5°	1800° ±5°	3600° ±5°	5400° ±5°	7200° ±5°
Total resistance 1.)	0.01 up to 100 kOhm	0.02 up to 100 kOhm	0.05 up to 200 kOhm	0.05 up to 200 kOhm	0.05 up to 500 kOhm
Resistance tolerance	< 1 kOhm ±5% (±3%) / ≥ 1 kOhm ±3% (±1%)				
Independent linearity (best straight line) 1.)	±0.3% (±0.2%)		±0.3% (±0.1%)		
Theoretical resolution 1.)	Depends on resistance value (see table below)				
Backlash (Hysteresis) 1.)	≤ 2°				
Rotational noise (ENR) 1.) (Method C)	100 Ohm				
Max. / recommended wiper current 1.)	35 mA / 2 µA				
Power rating @ 70 °C (0 W @ 105 °C)	2 W	2.5 W	5 W	7.5 W	10 W
Insulation Voltage 1.)	1000 VAC, 1min				
Insulation Resistance 1.)	100 MOhm @ 1000 VDC				

Mechanical Data, Environmental Conditions, Miscellaneous	3-turn	5-turn	10-turn	15-turn	20-turn
Mechanical angle of rotation 1.)	1080° +10°	1800° +10°	3600° +10°	5400° +10°	7200° +10°
Lifetime (90% el. eff. angle half sine) 2.)	0.6 Mio. rotations	1 Mio. rotations	2 Mio. rotations		
Max. operational speed	40 rev. / min.				
Bearing	Ball bearing				
Operational torque @ ambient temperature 1.) 2.)	10 Nmm				
End stop torque 1.) 2.)	90 Ncm				
Operating temperature range	-20 °C up to +105 °C				
Storage temperature range	-55 °C up to +105 °C				
Protection grade (IEC 60529)	IP40				
Vibration (IEC 68-2-6, Test Fc)	15g 10Hz to 2000Hz x 12h				
Shock (IEC 68-2-27, Test Ea)	49g @ 11 ms x 18				
Housing diameter	46 mm				
Housing depth	43.5 mm		61.5 mm	80 mm	100 mm
Shaft diameter	6 mm				
Shaft type	Solid shaft				

Data Sheet for Precision Potentiometer

Multiturn Wirewound Potentiometer

Series 46HDS

Mechanical Data, Environmental Conditions, Miscellaneous	3-turn	5-turn	10-turn	15-turn	20-turn
Max. radial load	≤1 N				
Max. axial load	≤1 N				
Connection type	Soldering lugs / pin (with option limit switch)				
Connection position	Axial				
Sensor mounting	Servo flange				
Mass	ca. 100 g		ca. 130 g	ca. 160 g	ca. 190 g
Fastening parts included in delivery	3 x servo clamps SFN1				
Material shaft	Stainless steel				
Material housing	Aluminium				

1.) According IEC 60393

2.) Determined by climatic conditions according to IEC 68-1, para. 5.3.1 without load collectives

Please note: Max. permissible supply voltage <75 VDC respectively <50 VAC in addition the max. power rating must be observed

Number of wire turns / resolution										
Resistance value Ohm	0,5	1	2	5	10	20	50	100	200	500
Number of wire turns (46HDS-3)	*	*	*	*	556	690	950	1190	1515	2080
Number of wire turns (46HDS-5)	*	*	*	*	*	925	1275	1650	2080	2860
Number of wire turns (46HDS-10)	*	*	*	*	*	*	2000	2500	3180	4350
Number of wire turns (46HDS-15)	*	*	*	*	*	*	2530	3220	4160	5710
Number of wire turns (46HDS-20)	*	*	*	*	*	*	3030	3920	5120	7140

Number of wire turns / resolution										
Resistance value Ohm	1k	2k	5k	10k	20k	50k	100k	200k	500k	
Number of wire turns (46HDS-3)	2550	2330	3225	4080	5130	6890	8330	-	-	
Number of wire turns (46HDS-5)	3450	3230	4170	5720	7410	11000	12500	-	-	
Number of wire turns (46HDS-10)	5400	6850	6600	8550	10850	14900	18850	24390	-	
Number of wire turns (46HDS-15)	7410	9510	8800	11300	14500	20000	25600	32250	-	
Number of wire turns (46HDS-20)	9300	11900	14100	13150	16950	23250	30790	38200	55550	

Resolution in degree E.g. R5k 5-turn = $1800^\circ / 4170 = 0.432^\circ$ per winding resistive wire

*marked potentiometers have a single-wire design. These potentiometers have an almost infinite resolution and are available on request for serial production

Data Sheet for Precision Potentiometer

Multiturn Wirewound Potentiometer

Series 46HDS

Order code									
Description	Selection: standard=black/bold , possible <i>options=grey/italic</i>								
Series:	46HDS								
Revolutions with stop:									
3-turn	03								
5-turn	05								
10-turn	10								
15-turn	15								
20-turn	20								
Resistance value /Option Tandem:					<i>Tandem</i>				
<i>Option 10 Ohm (only 3-turn)</i>				<i>R10</i>	<i>/10</i>				
<i>Option 20 Ohm (only 3 and 5-turn)</i>				<i>R20</i>	<i>/20</i>				
<i>Option 50 Ohm</i>				<i>R50</i>	<i>/50</i>				
<i>Option 100 Ohm</i>				<i>R100</i>	<i>/100</i>				
<i>Option 200 Ohm</i>				<i>R200</i>	<i>/200</i>				
<i>Option 500 Ohm</i>				<i>R500</i>	<i>/500</i>				
1 kOhm				R1k	/1k				
<i>Option 2 kOhm</i>				<i>R2k</i>	<i>/2k</i>				
5 kOhm				R5k	/5K				
10 kOhm				R10k	/10k				
<i>Option 20 kOhm</i>				<i>R20k</i>	<i>/20k</i>				
<i>Option 50 kOhm</i>				<i>R50k</i>	<i>/50k</i>				
<i>Option 100 kOhm</i>				<i>R100k</i>	<i>/100k</i>				
<i>Option 200 kOhm (only 10..20-turn)</i>				<i>R200k</i>	<i>/200k</i>				
<i>Option 500 kOhm (only 20-turn)</i>				<i>R500k</i>	<i>/500k</i>				
<i>Option rear shaft:</i>									
<i>Standard Ø6 x 15 mm</i>						<i>RA</i>			
<i>Shaft length in mm</i>						<i>RAxx,xx</i>			
<i>Shaft diameter in mm (≤6.35 mm)</i>						<i>RADMx,xx</i>			
Resistance tolerance:									
±5% @ < 1 kOhm							W5%		
±3% @ ≥ 1 kOhm							W3%		
<i>Option ±3% @ < 1kOhm</i>							<i>W3%</i>		
<i>Option ±1% @ ≥ 1kOhm</i>							<i>W1%</i>		
Independent linearity:									
±0,3%							L0,3%		
<i>Option ±0.2% (3 and 5-turn)</i>							<i>L0,2%</i>		
<i>Option ±0.1% (10, 15 and 20-turn)</i>							<i>L0,1%</i>		
Front shaft:									
Standard Ø6 x 16.5 mm								-	
<i>Option shaft diameter 6.35 mm</i>								<i>DM6,35</i>	
<i>shaft length in mm</i>								<i>Ax,xx</i>	
<i>Option shaft diameter in mm (≤6.35 mm)</i>								<i>DMx,xx</i>	
<i>Option screwdriver slot:</i>									<i>B</i>

For higher quantities or on-going demand, additional options are available as described below on request

For Example: Multi ganged potentiometers, sealed housing case, special electrical and mechanical angles of rotation, and special resistance and linearity tolerances, versions with resistive element as single wire with almost infinite resolution, 25 and 30-turn versions. Furthermore we can mount gear wheels or attach cable assemblies with or without connectors and much more.

Data Sheet for Precision Potentiometer



Multiturn Wirewound Potentiometer

Series 46HDS

Drawing

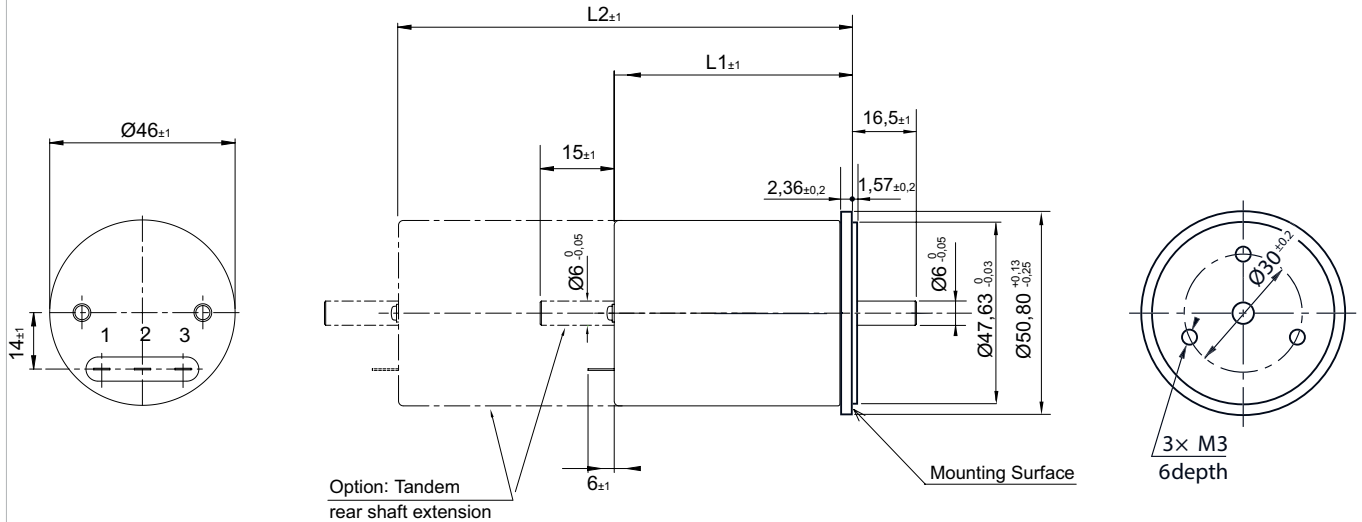

Version with limit switch

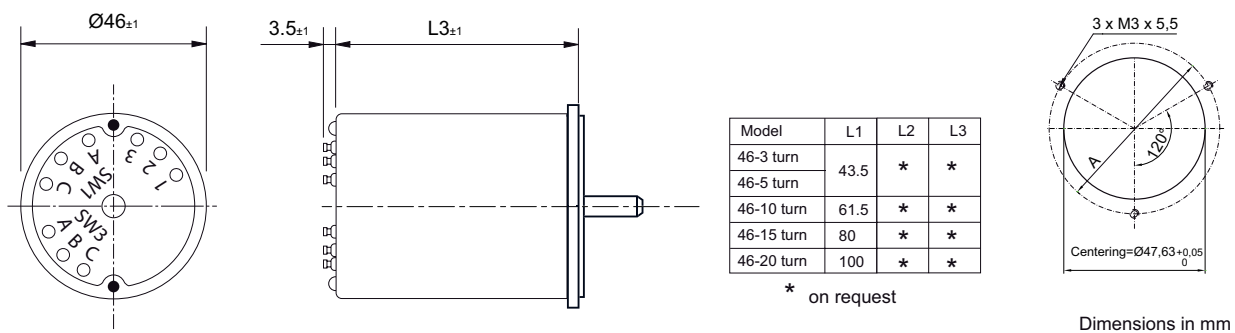

Dimensions in mm

Circumscription (standard)

Limit-Switch is activated outside effective electrical angle ($360^\circ \times n$).

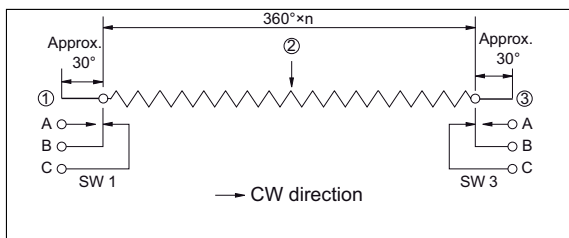

Inscription Type (option)

Limit-Switch is activated within effective electrical rotating angle ($360^\circ \times n$).

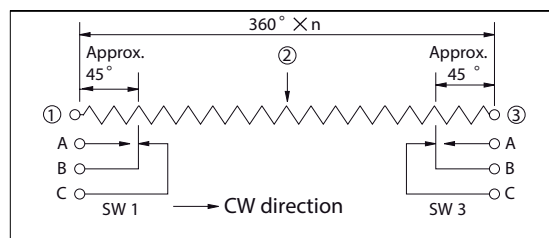

Limit switch

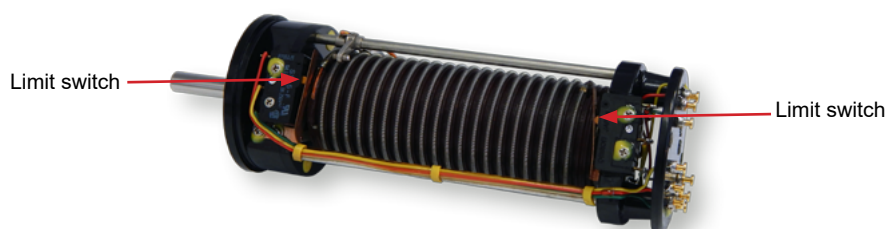

On Request: Special machining on shaft

Slot

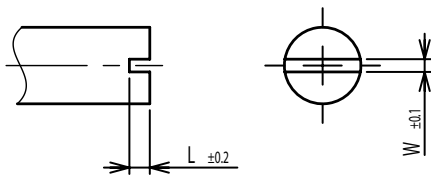

Groove

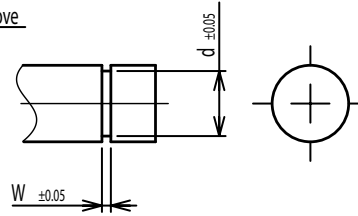

Flat



Round top

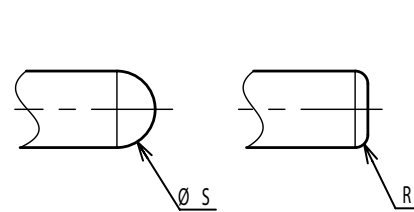

Double side flat



Counterbore hole

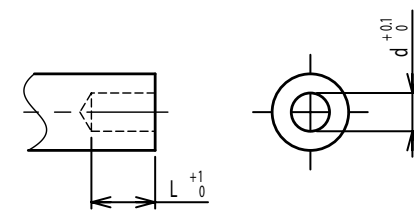

Step



Counterbore screw hole

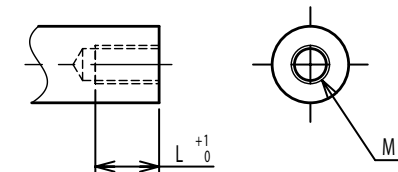

Screw Thread

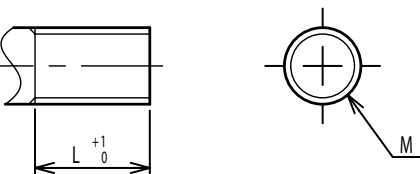

Pin hole

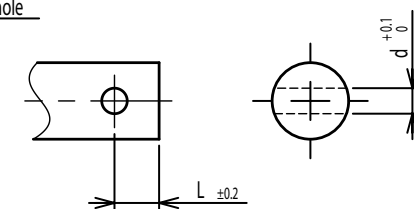

Knurled(Parallel)

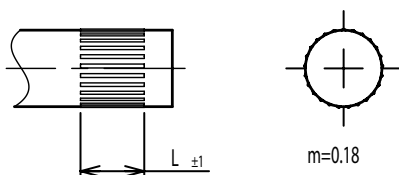

Screw thread inside hole

