

Data Sheet for Precision Potentiometer

Conductive Plastic Potentiometer

Series MCP22



The MCP22 potentiometers with precision ball bearings and servo flange are suitable for applications where a very long life span with high linearity and precisely mountable sensor is important.

- Very long life span
- Very precise sensor
- Servo flange for precise mounting
- 2 Precision ball bearings
- Robust metal housing

The precision potentiometers of the MCP22 series are designed for high demands on accuracy and reliability. They have good linearity and excellent life expectancy. The potentiometer is equipped with a servo flange for precise mounting. In closed loop controlled systems, the conductive plastic potentiometers can be used particularly advantageously. As passive components they do not cause any dead times due to signal propagation and the signal is infinitely available.

Electrical Data

Effective electrical angle of rotation 1.)	320° ±5°
Total resistance 1.)	500 Ohm..100 kOhm
Resistance tolerance	±10%
Independent linearity (best straight line) 1.)	±0.75% (±0.5%, ±0.2%)
Theoretical resolution 1.)	Nearly infinite
Backlash (Hysteresis) 1.)	≤ 0.5°
Max. / recommended wiper current 1.)	10 µA / 2 µA
Power rating @ 70°C (0W @ 105°C)	1 W
Insulation Voltage 1.)	1000 VAC, 1min
Insulation Resistance 1.)	1000 MOhm @ 1000 VDC

Mechanical Data, Environmental Conditions, Miscellaneous

Mechanical angle of rotation 1.)	360° without stop
Lifetime (90% el. eff. angle half sine) 2.)	50 Mio. rotations
Max. operational speed	400 rev. / min.
Bearing	2 x ball bearing
Operational torque @ ambient temperature 1.) 2.)	1.5 Nmm
Operating temperature range	-55 °C up to +125 °C
Storage temperature range	-55 °C up to +125 °C
Protection grade (IEC 60529)	IP40
Vibration (IEC 68-2-6, Test Fc)	15g 10 Hz up to 2000 Hz x 12h
Shock (IEC 68-2-27, Test Ea)	49g @ 11 ms x 18
Housing diameter	22.23 mm
Housing depth	15 mm
Shaft diameter	3 mm
Shaft type	Solid shaft

Data Sheet for Precision Potentiometer

Conductive Plastic Potentiometer

Series MCP22

Mechanical Data, Environmental Conditions, Miscellaneous

Max. radial load	≤1 N
Max. axial load	≤1 N
Connection type	Gold plated soldering pins
Connection position	Radial
Sensor mounting	Servo flange
Mass	15 g
Fastening parts included in delivery	3 servo clamps SFN2 with screw M3 x 7.5
Material shaft	Stainless steel
Material housing	Metal

1.) According IEC 60393

2.) Determined by climatic conditions according to IEC 68-1, para. 5.3.1 without load collectives

Please note: Max. permissible supply voltage <75 VDC respectively <50 VAC in addition the max. power rating must be observed

Order code

Description	Selection: standard=black/bold , possible <i>options=grey/italic</i>							
Serie	MCP22							
Resistance value /Option Tandem:			<i>Tandem</i>					
<i>Option 500 Ohm</i>		<i>R500</i>	<i>/500</i>					
1 kOhm		R1k	/1K					
<i>Option 2 kOhm</i>		<i>R2k</i>	<i>/2K</i>					
5 kOhm		R5k	/5K					
10 kOhm		R10k	/10k					
<i>Option 20 kOhm</i>		<i>R20K</i>	<i>/20k</i>					
<i>Option 50 kOhm</i>		<i>R50K</i>	<i>/50k</i>					
<i>Option 100 kOhm</i>		<i>R100K</i>	<i>/100k</i>					
<i>Option rear shaft:</i>								
<i>Standard Ø3,00 x 10 mm</i>				<i>RA</i>				
<i>Shaft length in mm</i>				<i>RAxx,xx</i>				
<i>Shaft diameter in mm (≤3,00 mm)</i>				<i>RADMx,xx</i>				
Resistance tolerance:								
±10%					W10%			
Independent linearity:								
±0,75%						L0,75%		
<i>Option ±0,5%</i>						<i>L0,5%</i>		
<i>Option ±0,2%</i>						<i>L0,2%</i>		
<i>Option center tap:</i>							<i>CT</i>	
Option front shaft:								
Standard Ø3,00 x 11,5 mm								-
<i>Option Ø 3,175 x 11,5 mm</i>								<i>DM3,175</i>
<i>Option shaft length in mm</i>								<i>Ax,xx</i>
<i>Option shaft diameter in mm (≤3,175 mm)</i>								<i>DMx,xx</i>
<i>Option screwdriver slot:</i>								<i>B</i>

For higher quantities or on-going demand, additional options are available as described below on request

For Example: Multi ganged potentiometers (max. 5), with mech. end stop 320° @ 30 Ncm, special electrical and mechanical angles of rotation, and special resistance and linearity tolerances. Furthermore we can mount gear wheels or attach cable assemblies with or without connectors and much more.

Data Sheet for Precision Potentiometer



Conductive Plastic Potentiometer

Series MCP22

Drawing

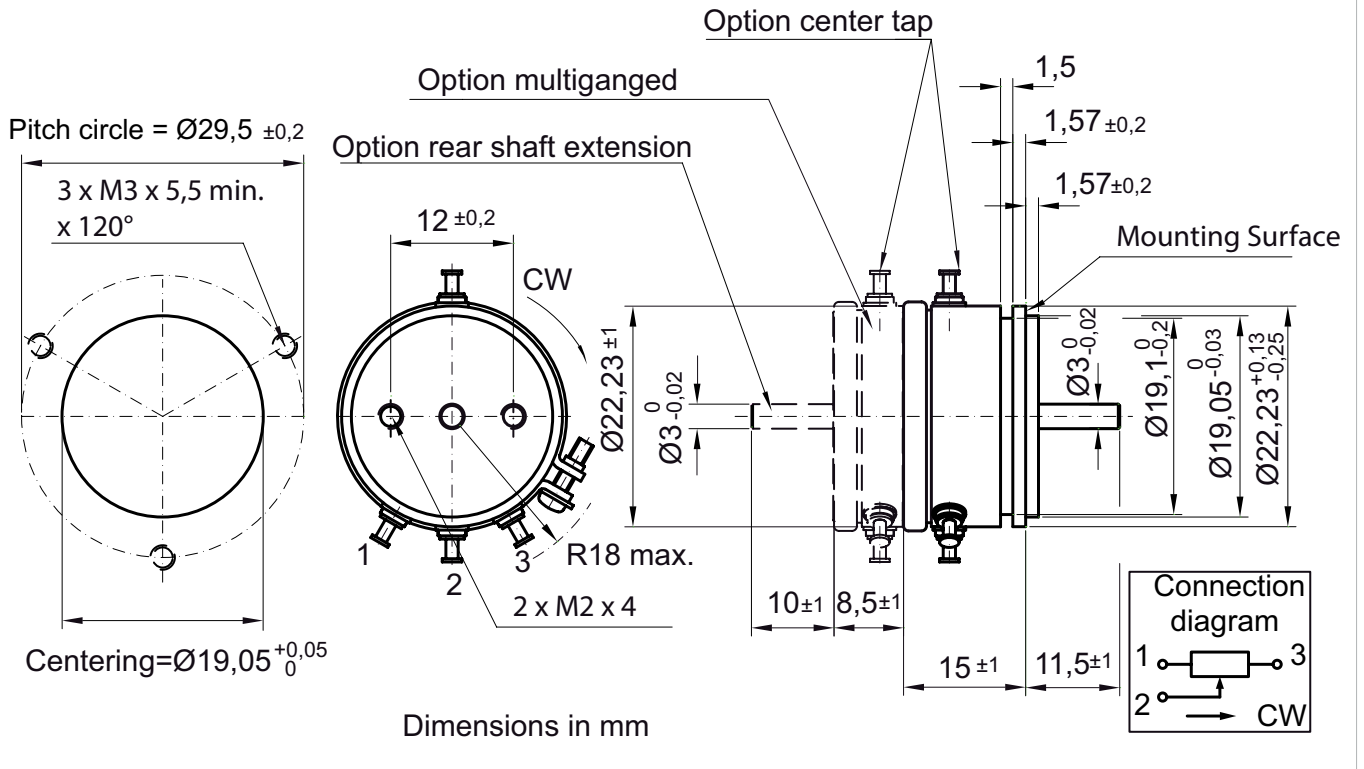

On Request: Special machining on shaft

Slot

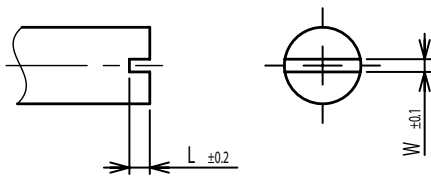

Groove

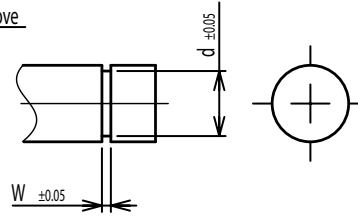

Flat

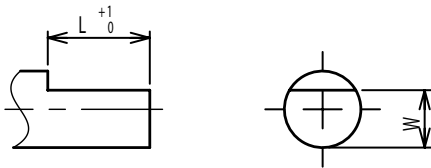

Round top

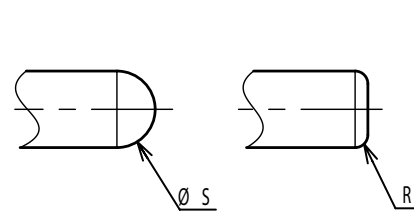

Double side flat

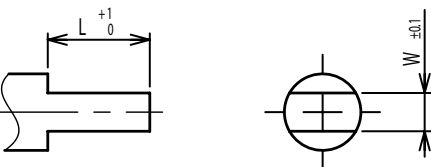

Counterbore hole

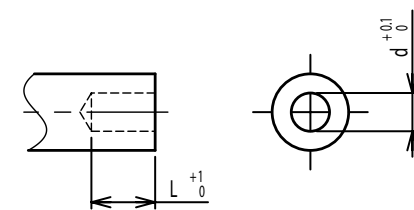

Step

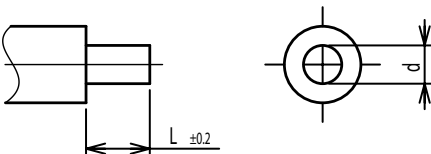

Counterbore screw hole

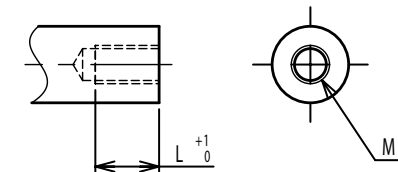

Screw Thread

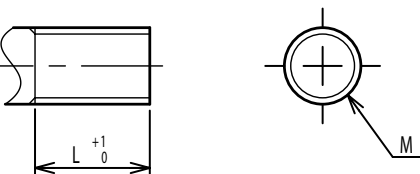

Pin hole

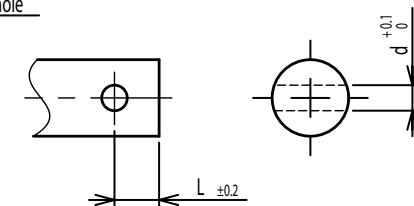

Knurled(Parallel)

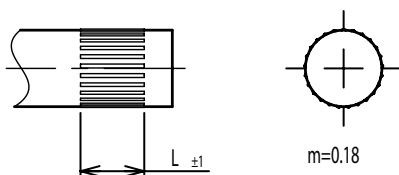

Screw thread inside hole

