

**JUMO GmbH & Co. KG**

Delivery address: Mackenrodtstraße 14  
36039 Fulda, Germany  
Postal address: 36035 Fulda, Germany  
Phone: +49 661 6003-0  
Fax: +49 661 6003-607  
Email: mail@jumo.net  
Internet: www.jumo.net

**JUMO Instrument Co. Ltd.**

JUMO House  
Temple Bank, Riverway  
Harlow, Essex, CM20 2DY, UK  
Phone: +44 1279 63 55 33  
Fax: +44 1279 62 50 29  
Email: sales@jumo.co.uk  
Internet: www.jumo.co.uk

**JUMO Process Control, Inc.**

6724 Joy Road  
East Syracuse, NY 13057, USA  
Phone: +1 315 437 5866  
Fax: +1 315 437 5860  
Email: info.us@jumo.net  
Internet: www.jumousa.com



## Screw-in and weld-in pockets

- For thermocouples and RTD temperature probes
- Thermometers can be replaced without draining the system
- Pockets in different materials
- Operating pressure up to 450 bar
- Available with acceptance certificate 3.1 (machined from solid)

Screw-in and weld-in pockets are used for installing thermocouples and RTD temperature probes whenever replacement without draining the system and/or pressure resistance are required.

The dimensions specified for **EL** refer to the fitting lengths of the thermometers; the dimension **L** indicates the fitting length of the pocket.

The pressure resistance is dependent on the temperature and is specified for each item. The maximum pressure that can be sealed on the thread depends on the installation conditions and may be lower. The pressure specifications contain no safety margin for additional loading through flow velocity.

**Acceptance test certificate:**

3.1, can be requested when ordering.  
Further sheaths, data sheet 902440

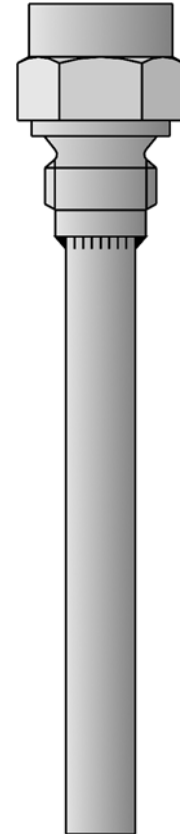

## Technical data

**Process connection**

for screwing in: G 1/2 (1/2" pipe), G 3/4 (3/4" pipe)  
for welding in: dia. 24H7, dia. 30H11

**Sheath**

Material:  
steel 1.0305  
stainless steel 1.4571  
steel 1.7335  
others on request

**Operating temperature range**

up to 450 °C, take note of loading diagrams!

**JUMO GmbH & Co. KG**  
 Delivery address: Mackenrodtstraße 14  
 36039 Fulda, Germany  
 Postal address: 36035 Fulda, Germany  
 Phone: +49 661 6003-0  
 Fax: +49 661 6003-607  
 Email: mail@jumo.net  
 Internet: www.jumo.net

**JUMO Instrument Co. Ltd.**  
 JUMO House  
 Temple Bank, Riverway  
 Harlow, Essex, CM20 2DY, UK  
 Phone: +44 1279 63 55 33  
 Fax: +44 1279 62 50 29  
 Email: sales@jumo.co.uk  
 Internet: www.jumo.co.uk

**JUMO Process Control, Inc.**  
 6724 Joy Road  
 East Syracuse, NY 13057, USA  
 Phone: +1 315 437 5866  
 Fax: +1 315 437 5860  
 Email: info.us@jumo.net  
 Internet: www.jumousa.com



**Dimensions**

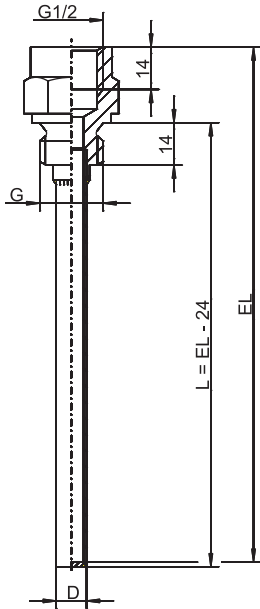

**Basic type 909710/10**  
**Basic type 909710/11**

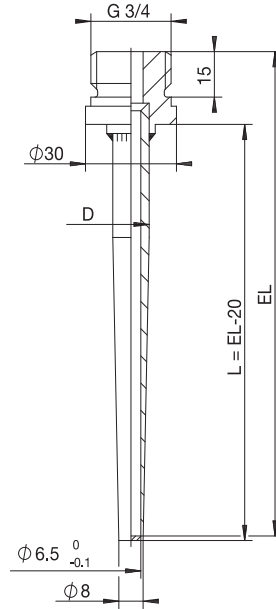

**Basic type 909712/15**

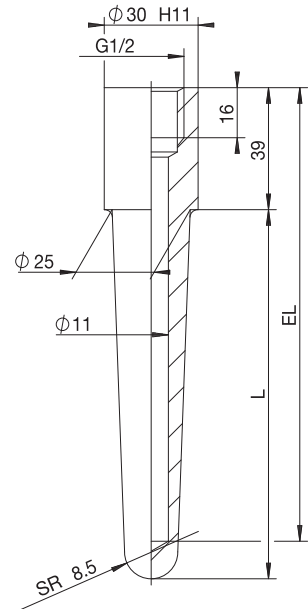

**Basic type 909712/20**

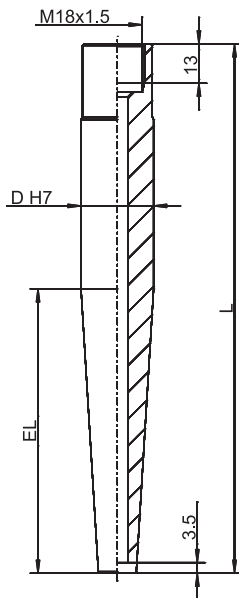

**Basic type 909712/50**  
**Basic type 909712/51**

**JUMO GmbH & Co. KG**  
 Delivery address: Mackenrodtstraße 14  
 36039 Fulda, Germany  
 Postal address: 36035 Fulda, Germany  
 Phone: +49 661 6003-0  
 Fax: +49 661 6003-607  
 Email: mail@jumo.net  
 Internet: www.jumo.net

**JUMO Instrument Co. Ltd.**  
 JUMO House  
 Temple Bank, Riverway  
 Harlow, Essex, CM20 2DY, UK  
 Phone: +44 1279 63 55 33  
 Fax: +44 1279 62 50 29  
 Email: sales@jumo.co.uk  
 Internet: www.jumo.co.uk

**JUMO Process Control, Inc.**  
 6724 Joy Road  
 East Syracuse, NY 13057, USA  
 Phone: +1 315 437 5866  
 Fax: +1 315 437 5860  
 Email: info.us@jumo.net  
 Internet: www.jumousa.com



### Loading diagrams

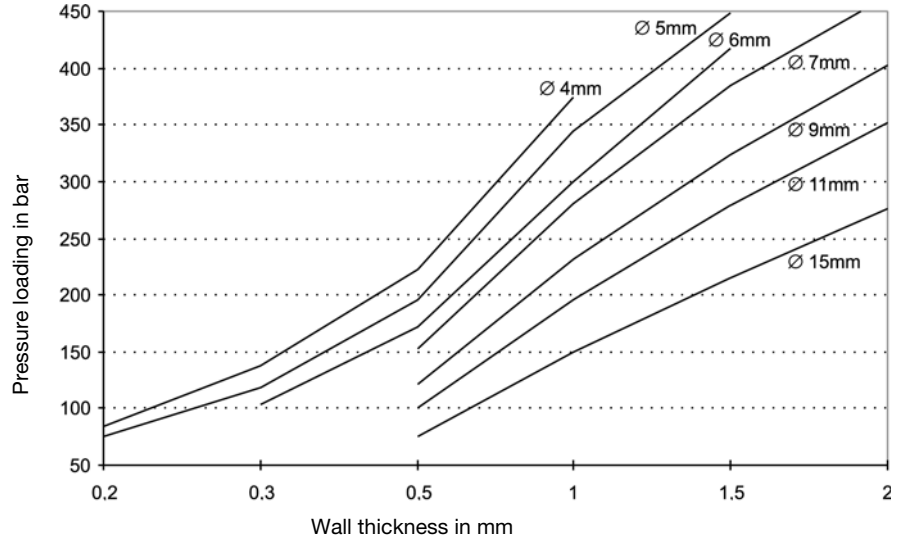
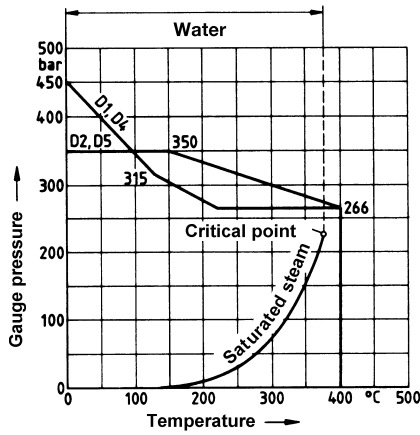

### Loading of sheaths

#### Form D according to 43763 Basic type 909712/50 and /51

Sheath: st. steel X6 CrNiMoTi 17 12 2,  
 Material Ref. 1.4571

Sheaths D1 and D4:  
 Permissible flow velocity for  
 air, water, superhdt. steam: up to 60 m/sec

Sheaths D2 and D5:  
 Permissible flow velocity  
 for air: up to 60 m/sec  
 for water, superheated steam: up to 30 m/sec

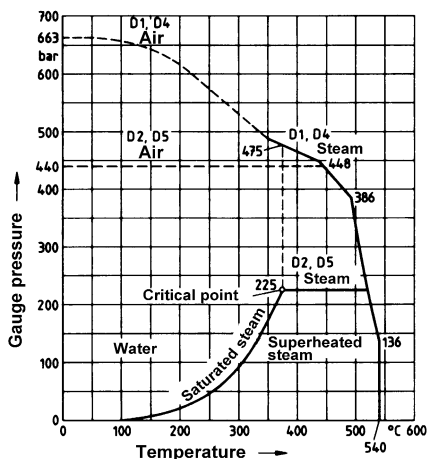

### Load limits on sheaths, for various sheath dimensions

The diagram shows the load limits (guide values) for different sheath dimensions. The maximum pressure loading of cylindrical sheaths is shown in relation to the wall thickness with different sheath diameters. The data refer to sheaths in stainless steel 1.4571, fitting length 100 mm, flow velocity 10 m/sec in air or 4 m/sec in water and a temperature range from -20 to +100 °C. A safety factor of 1.8 has been taken into account. For higher temperatures, or different materials, the maximum pressure loading has to be reduced by the percentage values given in the table.

Material	Temperature	Reduction
CrNi 1.4571	up to +200 °C	-10 %
CrNi 1.4571	up to +300 °C	-20 %
CrNi 1.4571	up to +400 °C	-25 %
CrNi 1.4571	up to +500 °C	-30 %
CuZn 2.0401	up to +100 °C	-15 %
CuZn 2.0401	up to +175 °C	-60 %

### Loading on sheaths

#### Form D according to 43763 Basic type 909712/50 and /51

Sheath: steel 13 CrMo 44,  
 Material Ref. 1.7335

Permissible flow velocity for  
 air and superheated steam: up to 60 m/sec

Loading in water: up to 450 bar  
 and up to 5 m/sec

**JUMO GmbH & Co. KG**  
 Delivery address: Mackenrodtstraße 14  
 36039 Fulda, Germany  
 Postal address: 36035 Fulda, Germany  
 Phone: +49 661 6003-0  
 Fax: +49 661 6003-607  
 Email: mail@jumo.net  
 Internet: www.jumo.net

**JUMO Instrument Co. Ltd.**  
 JUMO House  
 Temple Bank, Riverway  
 Harlow, Essex, CM20 2DY, UK  
 Phone: +44 1279 63 55 33  
 Fax: +44 1279 62 50 29  
 Email: sales@jumo.co.uk  
 Internet: www.jumo.co.uk

**JUMO Process Control, Inc.**  
 6724 Joy Road  
 East Syracuse, NY 13057, USA  
 Phone: +1 315 437 5866  
 Fax: +1 315 437 5860  
 Email: info.us@jumo.net  
 Internet: www.jumousa.com



**Order details: Screw-in pockets**

**(1) Basic type**

909710/10	Screw-in pocket, cylindrical, with female thread G 1/2 (1/2" pipe) (similar according to 16179 Form D)
-----------	--

909710/11	Screw-in pocket, cylindrical, with female thread G 1/2 (1/2" pipe) (DIN 16179 Form D)
-----------	---

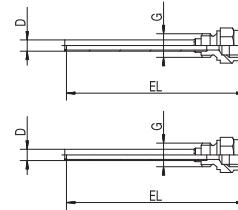

	<b>(2) Operating temperature in °C (also see loading diagram)</b>
x x	848 0 to 400 °C
	<b>(3) Sheath diameter D in mm</b>
x	8 outside diameter 8 mm/inside diameter 6.2 mm
x	13 outside diameter 13 mm/inside diameter 11 mm
	<b>(4) Fitting length EL in mm</b>
x x	100 100 mm
x	150 150 mm
x	160 160 mm
x x	250 250 mm
	<b>(5) Process connection</b>
x x	104 screw fitting G 1/2 (1/2" pipe thread)
	<b>(6) Sheath material</b>
x x	26 stainless steel 1.4571 (max. 400 °C)
	<b>(7) Extra codes</b>
x x	000 none

<b>Order code</b>	(1)	(2)	(3)	(4)	(5)	(6)	(7)
<b>Order example</b>	909710/10	- 848	- 8	- 100	- 104	- 26	/ 000

**JUMO GmbH & Co. KG**  
 Delivery address: Mackenrodtstraße 14  
 36039 Fulda, Germany  
 Postal address: 36035 Fulda, Germany  
 Phone: +49 661 6003-0  
 Fax: +49 661 6003-607  
 Email: mail@jumo.net  
 Internet: www.jumo.net

**JUMO Instrument Co. Ltd.**  
 JUMO House  
 Temple Bank, Riverway  
 Harlow, Essex, CM20 2DY, UK  
 Phone: +44 1279 63 55 33  
 Fax: +44 1279 62 50 29  
 Email: sales@jumo.co.uk  
 Internet: www.jumo.co.uk

**JUMO Process Control, Inc.**  
 6724 Joy Road  
 East Syracuse, NY 13057, USA  
 Phone: +1 315 437 5866  
 Fax: +1 315 437 5860  
 Email: info.us@jumo.net  
 Internet: www.jumousa.com



**Order details: Weld-in pockets**

**(1) Basic type**

909712/15	Weld-in pocket, tapered, with male thread G 3/4 (3/4" pipe) and acceptance test certificate 3.1 material
909712/20	Weld-in pocket, tapered, with female thread G 1/2 (1/2" pipe) (DIN 16179 Form S)
909712/50	Weld-in pocket, with female thread M 18x1.5 (DIN 43763 Form D1/D2)
909712/51	Weld-in pocket, with female thread M 18x1.5 (DIN 43763 Form D4/D5)

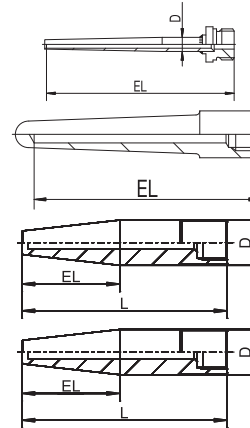

**(2) Operating temperature in °C (also see loading diagram)**

x x x x	848	0 to 400 °C
x x x x	854	0 to 500 °C

**(3) Sheath diameter D in mm**

x	12	outside diameter 12 mm stepped down to 8 mm/inside diameter 6.5 mm
x x	24	outside diameter 24 mm stepped down to 12.5 mm/inside diameter 7 mm
x	25	outside diameter 25 mm stepped down to 17 mm/inside diameter 11 mm

**(4) Fitting length EL in mm**

x	65 (140)	65 mm (L = 140 mm) <sup>1</sup> (Form D1)
x	65 (200)	65 mm (L = 200 mm) (Form D4)
x	100	100 mm
x	1235 (200)	125 mm (L = 200 mm) (Form D2)
x	125 (260)	125 mm (L = 260 mm) (Form D5)
x x	160	160 mm
x	190	190 mm
x	220	220 mm
x	250	250 mm

**(5) Process connection**

x x x x	000	weld-in pocket
---------	-----	----------------

**(6) Sheath material**

x	03	steel 1.0305
x x x	26	stainless steel 1.4571 (max. 400 °C)
x x x	36	steel 1.7335 (max. 500 °C)

**(7) Extra codes**

x x x	000	none
x x x	374	acceptance test certificate 3.1 material

<b>Order code</b>	(1)	(2)	(3)	(4)	(5)	(6)	(7)
<b>Order example</b>	909712/15	- 848	- 12	- 100	- 000	- 03	/ 374

<sup>1</sup> Example: 65 mm (L = 140 mm); 65 mm = EL taper, 140 mm = L pocket.

**JUMO GmbH & Co. KG**  
 Delivery address: Mackenrodtstraße 14  
 36039 Fulda, Germany  
 Postal address: 36035 Fulda, Germany  
 Phone: +49 661 6003-0  
 Fax: +49 661 6003-607  
 Email: mail@jumo.net  
 Internet: www.jumo.net

**JUMO Instrument Co. Ltd.**  
 JUMO House  
 Temple Bank, Riverway  
 Harlow, Essex, CM20 2DY, UK  
 Phone: +44 1279 63 55 33  
 Fax: +44 1279 62 50 29  
 Email: sales@jumo.co.uk  
 Internet: www.jumo.co.uk

**JUMO Process Control, Inc.**  
 6724 Joy Road  
 East Syracuse, NY 13057, USA  
 Phone: +1 315 437 5866  
 Fax: +1 315 437 5860  
 Email: info.us@jumo.net  
 Internet: www.jumousa.com



**Stock versions**

(1)	(2)	(3)	(4)	(5)	(6)	(7)	Part No.
909710/10	- 848	- 8	- 100	- 104	- 26	/ 000	90/00489140
909710/10	- 848	- 8	- 150	- 104	- 26	/ 000	90/00489141
909710/10	- 848	- 8	- 250	- 104	- 26	/ 000	90/00531795
909710/11	- 848	- 13	- 100	- 104	- 26	/ 000	90/00044862
909710/11	- 848	- 13	- 160	- 104	- 26	/ 000	90/00044863
909710/11	- 848	- 13	- 250	- 104	- 26	/ 000	90/00044864
909712/15	- 848	- 12	- 100	- 000	- 03	/ 000	90/00039349
909712/15	- 848	- 12	- 160	- 000	- 03	/ 000	90/00032010
909712/15	- 848	- 12	- 190	- 000	- 03	/ 000	90/00038739
909712/15	- 848	- 12	- 220	- 000	- 03	/ 000	90/00035520
909712/20	- 848	- 25	- 160	- 000	- 26	/ 000	90/00045048
909712/20	- 848	- 25	- 250	- 000	- 26	/ 000	90/00045049
909712/20	- 854	- 25	- 160	- 000	- 36	/ 000	90/00045411
909712/20	- 854	- 25	- 250	- 000	- 36	/ 000	90/00045412
909712/50	- 848	- 24	- 65 (140)	- 000	- 26	/ 000	90/00348538
909712/50	- 848	- 24	- 125 (200)	- 000	- 26	/ 000	90/00340509
909712/51	- 848	- 24	- 65 (200)	- 000	- 26	/ 000	90/00340384
909712/51	- 848	- 24	- 125 (260)	- 000	- 26	/ 000	90/00348540
909712/50	- 854	- 24	- 65 (140)	- 000	- 36	/ 000	90/00348539
909712/50	- 854	- 24	- 125 (200)	- 000	- 36	/ 000	90/00317838
909712/51	- 854	- 24	- 65 (200)	- 000	- 36	/ 000	90/00102673
909712/51	- 854	- 24	- 125 (260)	- 000	- 36	/ 000	90/00340381