

JUMO GmbH & Co. KG
 Delivery address: Mackenrodtstraße 14
 36039 Fulda, Germany
 Postal address: 36035 Fulda, Germany
 Phone: +49 661 6003-0
 Fax: +49 661 6003-607
 Email: mail@jumo.net
 Internet: www.jumo.net

JUMO Instrument Co. Ltd.
 JUMO House
 Temple Bank, Riverway
 Harlow, Essex, CM20 2DY, UK
 Phone: +44 1279 63 55 33
 Fax: +44 1279 62 50 29
 Email: sales@jumo.co.uk
 Internet: www.jumo.co.uk

JUMO Process Control, Inc.
 6724 Joy Road
 East Syracuse, NY 13057, USA
 Phone: +1 315 437 5866
 Fax: +1 315 437 5860
 Email: info.us@jumo.net
 Internet: www.jumousa.com



JUMO safetyM STB/STW

Safety Temperature Limiter, Safety Temperature Monitor

According to DIN EN 14597

Brief description

The safety temperature limiter JUMO safetyM STB and the safety temperature monitor JUMO safetyM STW are used to reliably detect and avert hazards that could cause injuries to people, that could be harmful to the environment, or that could cause destruction of production plants and produced goods at an early stage.

Its primary task is to reliably monitor thermal processes and switch the systems to an operational safe status in the event of malfunctions.

The measured value at the analog input can be recorded by various probes or standard signals. The exceedance of the limit value is indicated by the installed LEDs K1 and K2 (red) for each channel, and the **safety relevant relay output alarm (terminal 14 and 16)** switches the system to an operational safe status (**alarm range**).

The high standards of DIN EN 61508 and DIN EN ISO 13849 are met by a device concept that has a 1oo2D structure (2-channel structure with diagnostic channel) which ensures reliable detection of errors. This device concept can also be used for applications that correspond to the new machinery directive 2006/42/EC.



Type 701150/ ... 58

Block diagram

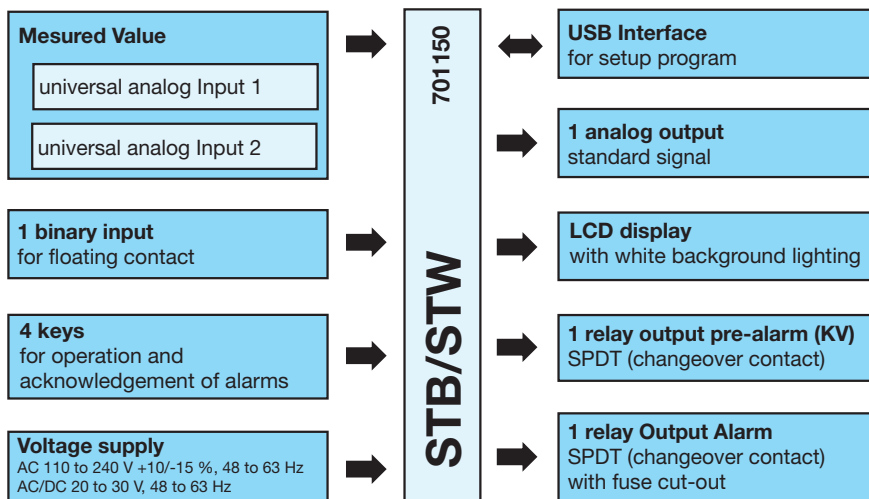

Special features

- 1oo2D structure for a high degree of process safety and reliability
- LCD display with background lighting and plain text display for more comfortable operation
- Setup program for configuration and archiving via USB interface
- Digital input filter with adjustable filter time constant
- Pre-alarm absolute, adjustable as a margin from the limit value or window function
- Wide voltage supply range from AC 110 to 240 V +10 %/-15 % or AC/DC 20 to 30 V
- Can be configured as STB or STW
- 12 linearizations can be set
- Internal and external unlocking possible
- Approvals for DIN EN 14597, SIL, PL (Performance Level), GI and UL
- Two relay outputs can be used as pre-alarm or limit value alarm

Approvals/approval marks (see "Technical Data")



JUMO GmbH & Co. KG
 Delivery address: Mackenrodtstraße 14
 36039 Fulda, Germany
 Postal address: 36035 Fulda, Germany
 Phone: +49 661 6003-0
 Fax: +49 661 6003-607
 Email: mail@jumo.net
 Internet: www.jumo.net

JUMO Instrument Co. Ltd.
 JUMO House
 Temple Bank, Riverway
 Harlow, Essex, CM20 2DY, UK
 Phone: +44 1279 63 55 33
 Fax: +44 1279 62 50 29
 Email: sales@jumo.co.uk
 Internet: www.jumo.co.uk

JUMO Process Control, Inc.
 6724 Joy Road
 East Syracuse, NY 13057, USA
 Phone: +1 315 437 5866
 Fax: +1 315 437 5860
 Email: info.us@jumo.net
 Internet: www.jumousa.com



Technical data

Analog inputs

RTD temperature probe

Designation	Measuring range	Accuracy 2/3-wire circuit ¹	Ambient temperature error
Pt100 DIN IEC 60751:2008	-200 to +850 °C	0.5 %/0.1 %	50 ppm/K
Pt1000 DIN IEC 60751:2008	-200 to +850 °C	0.5 %/0.1 %	50 ppm/K
Connection type	Maximum lead wire resistance 2-wire circuit 15 Ω, 3-wire circuit 30 Ω		
Sampling rate	210 ms		
Error tolerance time	≤ 5 s: time taken into account for all diagnostic tests		
Input filter	Digital filter, 2nd order; filter constant can be set from 0 to 100 s		
Special features	Single probe Pt100 2-wire, display can also be programmed in °F		

Thermocouples

Designation	Measuring range	Accuracy ¹	Ambient temperature influence
Fe-CuNi "L" DIN 43710: 1985-12	-200 to +900 °C	0.4 %	100 ppm/K
Fe-CuNi "J" DIN EN 60584-1:1996-10	-200 to +1200 °C	0.4 %	100 ppm/K
Cu-CuNi "U" DIN 43710:1985-12	-200 to +600 °C	0.4 %	100 ppm/K
Cu-CuNi "T" DIN EN 60584-1:1996-10	-200 to +400 °C	0.4 %	100 ppm/K
NiCr-Ni "K" DIN EN 60584-1:1996-10	-200 to +1372 °C	0.4 %	100 ppm/K
Pt10Rh-Pt "S" DIN EN 60584-1:1996-10	-50 to +1768 °C	0.4 %	100 ppm/K
Pt13Rh-Pt "R" DIN EN 60584-1:1996-10	-50 to +1768 °C	0.4 %	100 ppm/K
Pt30Rh-Pt6Rh "B" DIN EN 60584-1:1996-10	0 to 1820 °C	0.4 % ²	100 ppm/K
NiCrSi-NiSi „N“ DIN EN 60584-1:1996-10	-100 to +1300 °C	0.4 % ²	100 ppm/K
W3Re-W25Re "D" ASTM E1751M-09 (bis 2315 °C): 2009	0 to 2495 °C	0.4 %	100 ppm/K
W5Re-W26Re „C“ ASTM E230M-11: 2011	0 to 2315 °C	0,4 %	100 ppm/K
Cold junction	Pt100 internal		
Cold junction accuracy	±1 K		
Sampling rate	210 ms		
Error tolerance time	≤ 5 s: time taken into account for all diagnostic tests		
Input filter	Digital filter, 2nd order; filter constant can be set from 0 to 100 s		

1. The accuracy refers to the maximum extent of the measuring range.

2. The accuracy is guaranteed above 300° C

Direct current

Measuring range	Accuracy	Ambient temperature influence
4 to 20mA, voltage drop < 2 V	0.2 %	150 ppm/K
Scaling	Can be freely programmed within the limits	
Sampling rate	210 ms	
Error tolerance time	≤ 5 s: time taken into account for all diagnostic tests	
Input filter	Digital filter, 2nd order; filter constant can be set from 0 to 100 s	
Special features	Single probe 4 to 20 mA	

Analog output

	Signal type	Accuracy	Residual ripple	Load influence	Temperature influence	Load resistance
Current	4 to 20 mA	≤ 0.5 %	± 0.5 % at 300 Ω	± 0.05 mA/100Ω	150 ppm/K	≤ 500 Ω
	0 to 20 mA					
Voltage	2 to 10 V	≤ 0.5 %	± 0.5 %	± 15 mV	150 ppm/K	± 500 Ω
	0 to 10 V					

JUMO GmbH & Co. KG
 Delivery address: Mackenrodtstraße 14
 36039 Fulda, Germany
 Postal address: 36035 Fulda, Germany
 Phone: +49 661 6003-0
 Fax: +49 661 6003-607
 Email: mail@jumo.net
 Internet: www.jumo.net

JUMO Instrument Co. Ltd.
 JUMO House
 Temple Bank, Riverway
 Harlow, Essex, CM20 2DY, UK
 Phone: +44 1279 63 55 33
 Fax: +44 1279 62 50 29
 Email: sales@jumo.co.uk
 Internet: www.jumo.co.uk

JUMO Process Control, Inc.
 6724 Joy Road
 East Syracuse, NY 13057, USA
 Phone: +1 315 437 5866
 Fax: +1 315 437 5860
 Email: info.us@jumo.net
 Internet: www.jumousa.com



Binary input

Connection	Function
1 floating contact	Unlocking, key inhibit, level inhibit can be configured

Relay outputs

Relay output KV	Relay (changeover contact) without contact protection 30000 switching operations at a switching capacity of 250 V, 3 A, 50 Hz (resistive load) or up to DC 30 V, 3 A. Minimum current DC 12 V, 100 mA.
Relay output alarm	Relay (changeover contact) Contact protection circuit: fuse cut-out 3.15 AT, installed in the pole contact arm 30000 switching actions at a switching capacity of 230 V, 3 A, 50 Hz (resistive load) or up to DC 30 V, 3 A. Minimum current DC 12 V, 100 mA.

Measuring circuit monitoring

	RTD temperature probe in 3-wire circuit and double thermocouples	Thermocouples	Current 4 to 20 mA
Overrange and underrange	Is detected LED K1, K2, KD, and KV are lit; ">>>>" flashes in the display for overrange, "<<<<" for underrange.		
Probe/cable break	Is detected LED K1, K2, KD, and KV are lit ">>>>" flashes in the display; relay output alarm is inactive		LED K1, K2, KD, and KV are lit; ">>>>" flashes in the display; relay output alarm is inactive
Probe short circuit	Is detected LED K1, K2, KD, and KV are lit "<<<<" flashes in the display; relay output alarm is inactive	Is detected by difference monitoring of the analog inputs	LED K1, K2, KD, and KV are lit; "<<<<" flashes in the display; relay output alarm is inactive

Voltage supply

Voltage supply	AC/DC 20 to 30V, 48 to 63 Hz	AC 110 to 240V +10% /-15%, 48 to 63 Hz
Power consumption, Power loss	max. 12 W	max. 12 W
Power consumption, Power loss for the following mode: Analog output 10mA; background lighting Display off; Relay output "Alarm" on; Relay output pre-alarm off; Sensor: 2xPt100	5 W	5 W

Test voltages according to EN 60730, part 1

Input and output against voltage supply	
- At voltage supply AC 110 to 240 V +10 % / -15 %	3.7 kV/50 Hz
- At voltage supply AC/DC 20 to 30 V, 48 to 63 Hz	3.7 kV/50 Hz

Electrical safety

	Clearances / creepage distances
Mains voltage to electronic components and probes	≥ 6 mm / ≥ 8 mm
Mains voltage to the relay	≥ 6 mm / ≥ 8 mm
Relay to electronic components and probes	≥ 6 mm / ≥ 8 mm
Electrical safety	According to DIN EN 14597 (DIN EN 60730-2-9) Overvoltage category III, pollution degree 2
Protection rating I	With internal separation to SELV electrical circuits

JUMO GmbH & Co. KG
 Delivery address: Mackenrodtstraße 14
 36039 Fulda, Germany
 Postal address: 36035 Fulda, Germany
 Phone: +49 661 6003-0
 Fax: +49 661 6003-607
 Email: mail@jumo.net
 Internet: www.jumo.net

JUMO Instrument Co. Ltd.
 JUMO House
 Temple Bank, Riverway
 Harlow, Essex, CM20 2DY, UK
 Phone: +44 1279 63 55 33
 Fax: +44 1279 62 50 29
 Email: sales@jumo.co.uk
 Internet: www.jumo.co.uk

JUMO Process Control, Inc.
 6724 Joy Road
 East Syracuse, NY 13057, USA
 Phone: +1 315 437 5866
 Fax: +1 315 437 5860
 Email: info.us@jumo.net
 Internet: www.jumousa.com



Environmental influences





Ambient temperature range	0 to +55 °C
Storage temperature range	-30 to +70 °C
Site altitude	maximum 2000 m above MSL
Temperature influence	$\leq \pm 0.005 \% / K$ dev. from $23 \times C^1$ for RTD temperature probe $\leq \pm 0.01 \% / K$ dev. from $23 \times C^1$ for thermocouple, current
Terminal temperature Range	If the temperature range of -10 °C to +80 °C is exceeded or undercut, the device shows the error message "Terminal temperature Range". The output changes to a safe state (quiescent current principle). The message can only be acknowledged, if the temperature is back again in the valid range.
Resistance to climatic conditions	85 % rel. humidity without condensation (3K3 with extended temperature range according to DIN EN 60721-3-3)
EMC	According to DIN EN 14597 and standards from the standard series DIN EN 61326
Interference emission	Class B
Interference immunity	Evaluation criteria FS according to DIN EN 14597, regulation and control devices (RS)

1. All specifications refer to the measuring range end value

Case

Material	Polycarbonate
Flammability class	UL 94 V0
Electrical connection	On the front via screw terminals up to 2.5 mm ²
Installation	On 35 mm DIN rail acc. to EN 60715
Installation position	vertical
Weight	Approx. 230 g
Protection type	IP 20 acc. to EN 60529

Approvals/approval marks

	Designation Testing agency Certifikate no. Inspection basis Valid for	DIN DIN CERTCO STB/STW1223 DIN EN 14597 All device versions
	Designation Testing agency Certifikate no. Inspection basis Valid for	SIL2, SIL3 TÜV Nord SEBS-A.102606/16-1 V2.0 DIN EN 61508, DIN EN 60730-2-9, DIN EN 14597 Devices with extra code 058
	Designation Testing agency Certifikate no. Inspection basis Valid for	PL e TÜV Nord SEBS-A.102606/16-1 V2.0 DIN EN ISO 13849-1 Devices with extra code 058
	Designation Testing agency Certifikate no. Inspection basis Valid for	UL Underwriters Laboratories File Nr.: E325456 UL 60730-2-9, UL 60730-1, UL 60730-2-9, CAN/CSA-E60730-1, CAN/CSA-E60730-2-9 All device versions
	Designation Testing agency Certifikate no. Inspection basis Valid for	DNV DNV TAA000017J DNV GL rules for classification - Ships, offshore units, and high speed and light craft Devices with extra code 062

JUMO GmbH & Co. KG
 Delivery address: Mackenrodtstraße 14
 36039 Fulda, Germany
 Postal address: 36035 Fulda, Germany
 Phone: +49 661 6003-0
 Fax: +49 661 6003-607
 Email: mail@jumo.net
 Internet: www.jumo.net

JUMO Instrument Co. Ltd.
 JUMO House
 Temple Bank, Riverway
 Harlow, Essex, CM20 2DY, UK
 Phone: +44 1279 63 55 33
 Fax: +44 1279 62 50 29
 Email: sales@jumo.co.uk
 Internet: www.jumo.co.uk

JUMO Process Control, Inc.
 6724 Joy Road
 East Syracuse, NY 13057, USA
 Phone: +1 315 437 5866
 Fax: +1 315 437 5860
 Email: info.us@jumo.net
 Internet: www.jumousa.com



EAC	Designation	EAC
	Testing agency	Меридиан
UKCA	Certificate no.	EAЭС N RU Д-DE.МН06.В.17659/19
	Inspection basis	TP TC 004/2011, TP TC 020/2011
	Valid for	All device versions
	Designation	UKCA
UKCA	Testing agency	
	Certificate no.	
	Inspection basis	
	Valid for	All device versions

Display and control elements

Legend:	Comment	
3	LCD display Black/white with background lighting 96 x 64 pixels	
6	LED KV (yellow) Is lit if the pre-alarm is triggered.	
7	LED KD (yellow) Is lit if the diagnostic processor has performed a switch-off	
8	Keys (can only be operated when the transparent hood is folded upward) Increase value, Decrease value Programming RESET	
12	Setup interface	
13	LED K2 (red)^a Is always simultaneously lid with K1 when errors occur on analog input 1 or 2 or in the event of limit value exceedance	
14	LED K1 (red)^a Is always simultaneously lid with K2 when errors occur on analog input 1 or 2 or in the event of limit value exceedance	
15	LED OK Green: Good range Off: Error occurred	

a. The exceedance of the limit value is indicated by the installed LEDs K1 and K2 (red) for each channel, and the safety relevant relay output alarm (terminal 14 and 16) switches the system to an operational safe status (alarm range).

Electrical isolation

<p>(1) Analog inputs</p> <p>(3) Binary input</p> <p>(5) Setup interface</p> <p>(6) Display</p> <p>(7) Analog output</p> <p>(8) Voltage supply</p>		<p>(2) Relay output alarm</p> <p>(4) Relay output pre-alarm</p>
---	--	---



Switching behavior of the relay output pre-alarm

Absolute value or Limit val. dist. direct

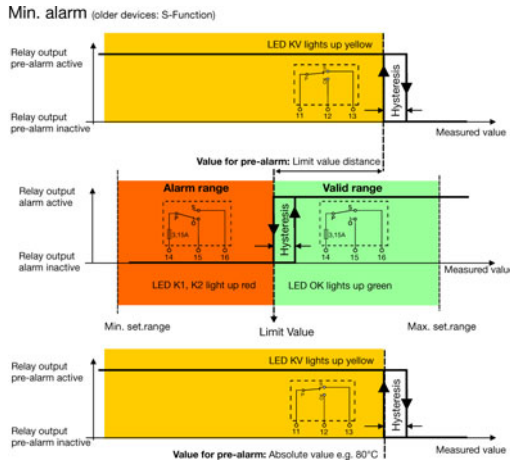

Absolute value or Limit val. dist. inverse

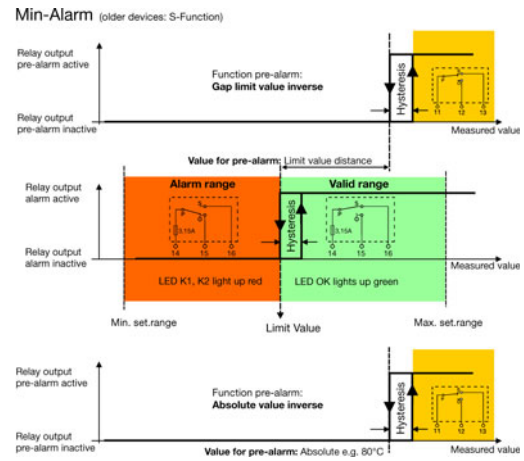

Max. alarm (older devices: O-Function)

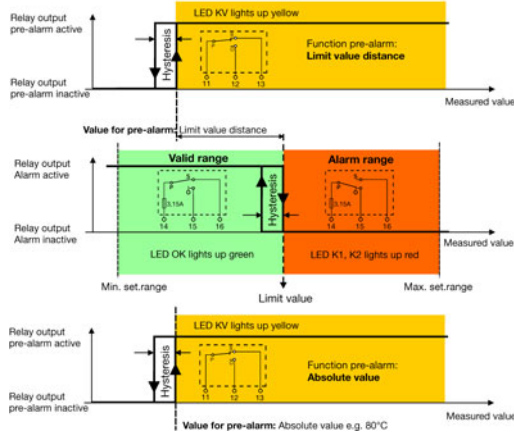

Max. alarm (older devices: O-Function)

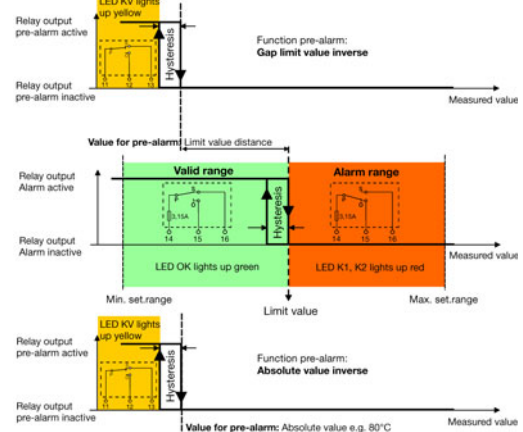

Window direct (it is irrelevant if Min-Alarm or Max-Alarm is set)

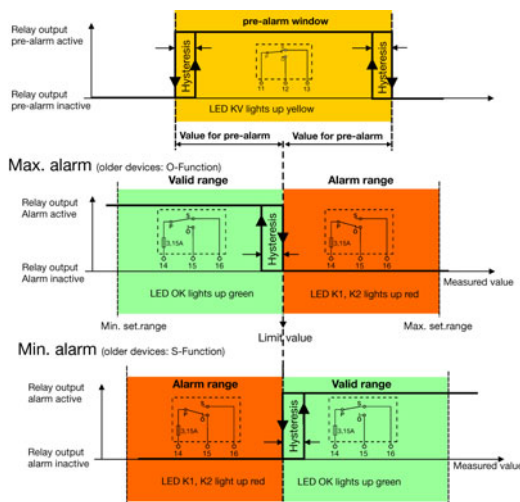

Window inverse (it is irrelevant if Min-Alarm or Max-Alarm is set)

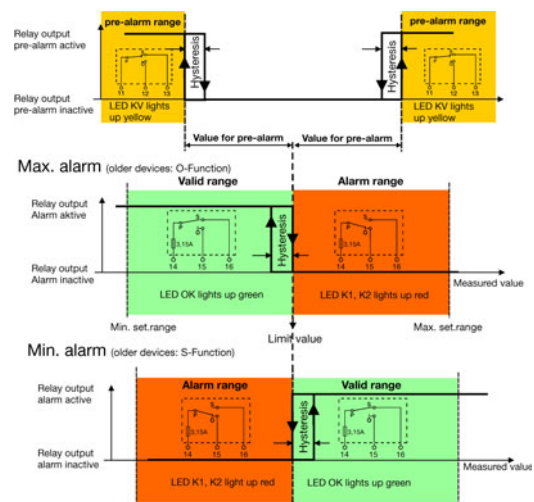



Switching behavior min. alarm

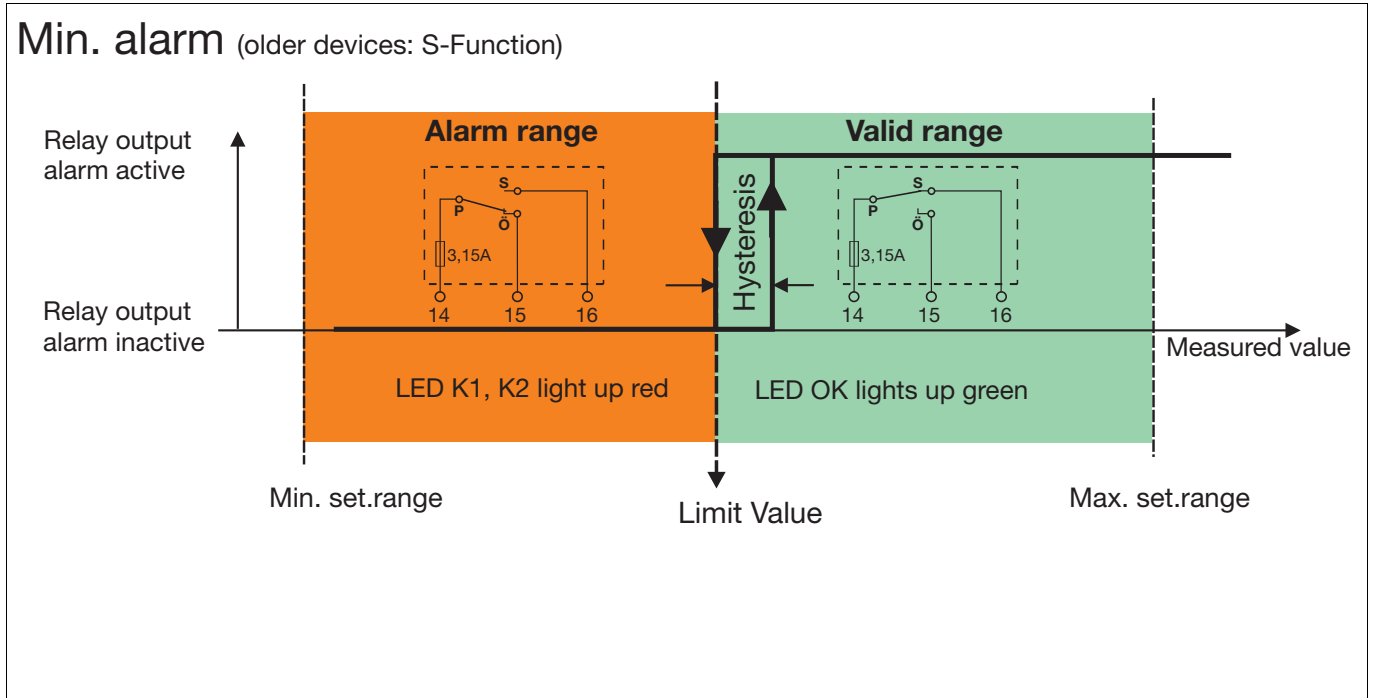

Switching behavior max. alarm (factory set)

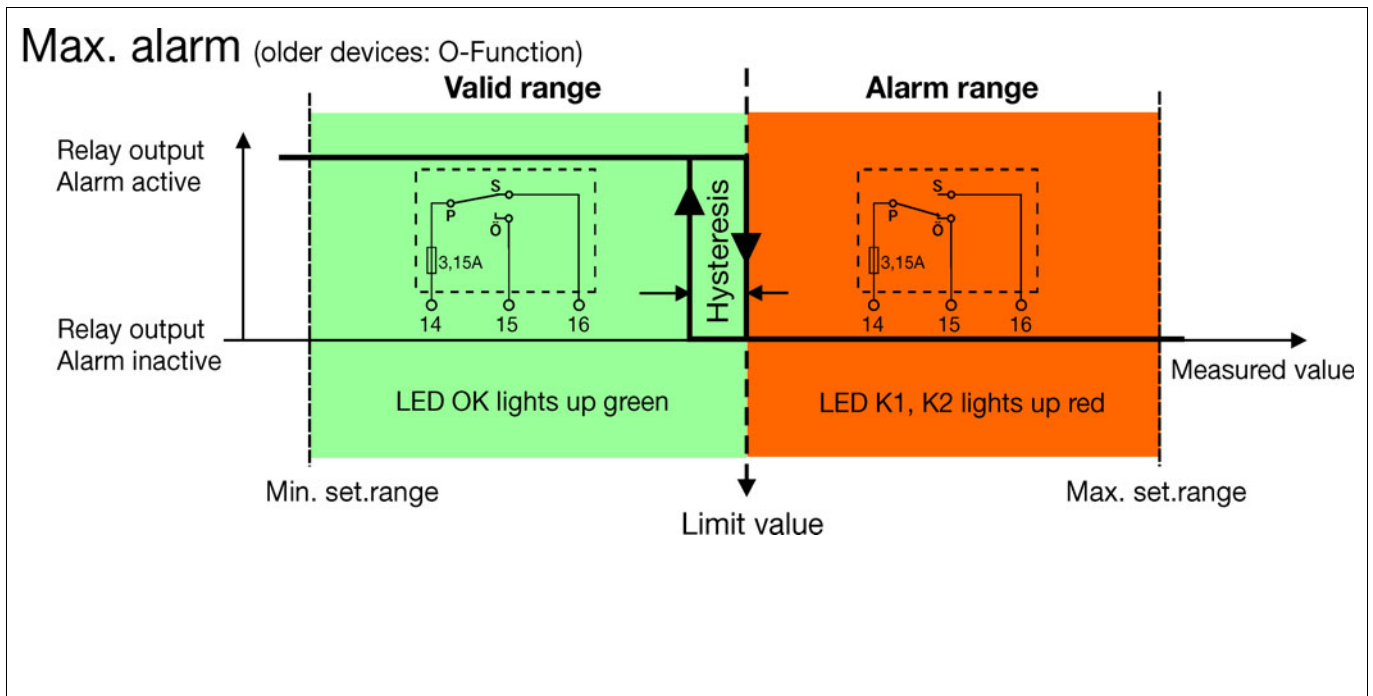

JUMO GmbH & Co. KG
 Delivery address: Mackenrodtstraße 14
 36039 Fulda, Germany
 Postal address: 36035 Fulda, Germany
 Phone: +49 661 6003-0
 Fax: +49 661 6003-607
 Email: mail@jumo.net
 Internet: www.jumo.net

JUMO Instrument Co. Ltd.
 JUMO House
 Temple Bank, Riverway
 Harlow, Essex, CM20 2DY, UK
 Phone: +44 1279 63 55 33
 Fax: +44 1279 62 50 29
 Email: sales@jumo.co.uk
 Internet: www.jumo.co.uk











JUMO Process Control, Inc.
 6724 Joy Road
 East Syracuse, NY 13057, USA
 Phone: +1 315 437 5866
 Fax: +1 315 437 5860
 Email: info.us@jumo.net
 Internet: www.jumousa.com



Connection diagram

The connection diagram in the data sheet provides preliminary information about the connection possibilities. For the electrical connection only use the installation instructions or the operating manual. The knowledge and the correct technical execution of the safety information/instructions contained in these documents are mandatory for installation, electrical connection, and startup as well as for safety during operation.

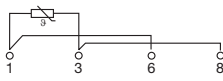
The connection occurs via screw terminals. 	Lead	Admissible cross section
	1 wire	≤ 2.5 mm ²
	Fine-strand, with ferrule	≤ 1.5 mm ²
	Tightening torque of the screws: max. 0.5 Nm	

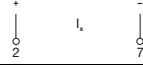
Legend:	Comment	Screw terminals	Screw terminals
1, 2		Analog input 1 (E1)	Analog input 2 (E2)
	Thermocouple, Double thermocouple		
	 When double-thermowells are connected to the measuring circuits (E1) and (E2) they have to be isolated. That means that both thermowells have no electrical connection to the protection fitting and furthermore no galvanically connection against each other (isolated assembly).		
	RTD temperature probe in 2-wire circuit		
	 Enter the lead wire resistance for RTD temperature probes in 2-wire circuit when using greater line lengths. Setup program: <i>analog inputs</i>		
	RTD temperature probe Pt100/Pt1000 in 3-wire circuit		
	RTD temperature probe Pt100 in 2-wire circuit, individual sensor for both analog inputs Caution: When only one probe (SIL2) is connected, the temperature limiter device is reduced from SIL3 to SIL2! However, the internal 2-channel structure (1oo2D) in the device is still retained. Both channels measure the same sensor due to the simplified external circuit.		
	(4) to 20 mA		
	(4) to 20 mA for both analog inputs		
	Caution: When only one probe (SIL2) is connected, the temperature limiter device is reduced from SIL3 to SIL2! However, the internal 2-channel structure (1oo2D) in the device is still retained. Both channels measure the same current signal due to the simplified external circuit.		

JUMO GmbH & Co. KG
 Delivery address: Mackenrodtstraße 14
 36039 Fulda, Germany
 Postal address: 36035 Fulda, Germany
 Phone: +49 661 6003-0
 Fax: +49 661 6003-607
 Email: mail@jumo.net
 Internet: www.jumo.net

JUMO Instrument Co. Ltd.
 JUMO House
 Temple Bank, Riverway
 Harlow, Essex, CM20 2DY, UK
 Phone: +44 1279 63 55 33
 Fax: +44 1279 62 50 29
 Email: sales@jumo.co.uk
 Internet: www.jumo.co.uk

JUMO Process Control, Inc.
 6724 Joy Road
 East Syracuse, NY 13057, USA
 Phone: +1 315 437 5866
 Fax: +1 315 437 5860
 Email: info.us@jumo.net
 Internet: www.jumousa.com



Legend:	Comment	Screw terminals	Screw terminals
4	Binary input Connection to a floating contact	Ground	
5	Analog output: 0 to 20 mA 4 to 20 mA (factory set) 0(2) to 10 V		
9	Voltage supply Acc. to nameplate	AC: L1 line conductor N neutral conductor	DC: (L+) (L-)
10	Relay output alarm (zero-current state) Relay (changeover contact) with fuse cut-out		
11	Relay output pre-alarm (KV) Relay (changeover contact)		

Dimensions

Type 701150/...

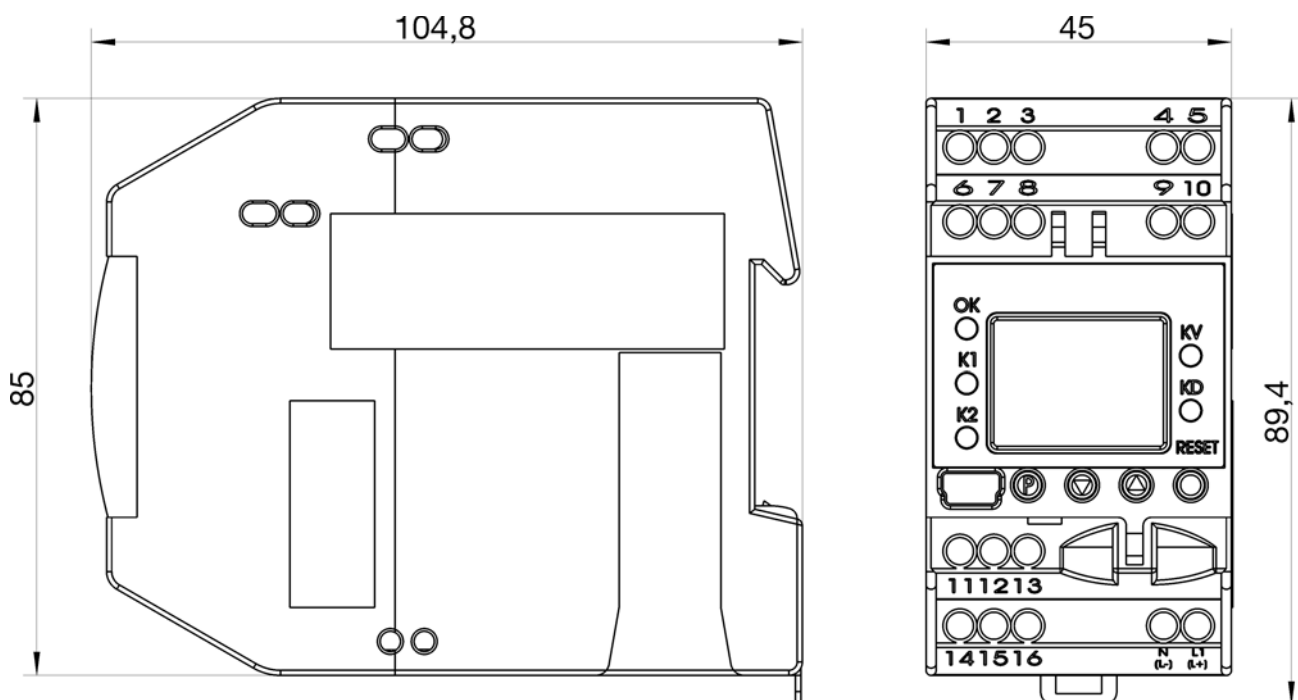

JUMO GmbH & Co. KG
 Delivery address: Mackenrodtstraße 14
 36039 Fulda, Germany
 Postal address: 36035 Fulda, Germany
 Phone: +49 661 6003-0
 Fax: +49 661 6003-607
 Email: mail@jumo.net
 Internet: www.jumo.net

JUMO Instrument Co. Ltd.
 JUMO House
 Temple Bank, Riverway
 Harlow, Essex, CM20 2DY, UK
 Phone: +44 1279 63 55 33
 Fax: +44 1279 62 50 29
 Email: sales@jumo.co.uk
 Internet: www.jumo.co.uk

JUMO Process Control, Inc.
 6724 Joy Road
 East Syracuse, NY 13057, USA
 Phone: +1 315 437 5866
 Fax: +1 315 437 5860
 Email: info.us@jumo.net
 Internet: www.jumousa.com



Probes for the operating-medium air

Note: Due to the response accuracy, use is only permitted without pockets (thermowells).

Actual type designation	Probe type	Temperature range	Nom. length mm	Process connection
RTD temperature probe Data Sheet 902006				
902006/65-228-1003-1-15-500-668/000	1 x Pt100	-170 ... +700°C	500	Stop flange movable
902006/65-228-1003-1-15-710-668/000			710	
902006/65-228-1003-1-15-1000-668/000			1000	
902006/55-228-1003-1-15-500-254/000	1 x Pt100	-170 ... +700°C	500	movable G1/2 compression clamp
902006/55-228-1003-1-15-710-254/000			710	
902006/55-228-1003-1-15-1000-254/000			1000	
902006/65-228-2003-1-15-500-668/000	2 x Pt100	-170 ... +700°C	500	Stop flange movable
902006/65-228-2003-1-15-710-668/000			710	
902006/65-228-2003-1-15-1000-668/000			1000	
902006/55-228-2003-1-15-500-254/000	2 x Pt100	-170 ... +700°C	500	movable G1/2 compression clamp
902006/55-228-2003-1-15-710-254/000			710	
902006/55-228-2003-1-15-1000-254/000			1000	
Thermocouples Data Sheet 901006				
901006/65-547-2043-15-500-668/000	2 x NiCr-Ni, Typ „K“	-35 ... +800°C	500	Stop flange movable
901006/65-547-2043-15-710-668/000			710	
901006/65-547-2043-15-1000-668/000			1000	
901006/65-546-2042-15-500-668/000	2 x Fe-CuNi, Typ „L“	-35 ... +700°C	500	Stop flange movable
901006/65-546-2042-15-710-668/000			710	
901006/65-546-2042-15-1000-668/000			1000	
901006/66-550-2043-6-500-668/000	2 x NiCr-Ni, Typ „K“	-35 ... +1000°C	500	Stop flange movable
901006/66-550-2043-6-355-668/000			355	
901006/66-550-2043-6-250-668/000			250	
901006/66-880-1044-6-250-668/000	1 x PT10Rh-PT, Typ „S“	0 ... 1300°C	250	Stop flange movable
901006/66-880-1044-6-355-668/000			355	
901006/66-880-1044-6-500-668/000			500	
901006/66-880-2044-6-250-668/000	2 x PT10Rh-PT, Typ „S“	0 ... 1300°C	250	Stop flange movable
901006/66-880-2044-6-355-668/000			355	
901006/66-880-2044-6-500-668/000			500	
901006/66-953-1046-6-250-668/000	1 x PT30Rh-PT6Rh, Typ „B“	600 ... 1500°C	250	Stop flange movable
901006/66-953-1046-6-355-668/000			355	
901006/66-953-1046-6-500-668/000			500	
901006/66-953-2046-6-250-668/000	2 x PT30Rh-PT6Rh, Typ „B“	600 ... 1500°C	250	Stop flange movable
901006/66-953-2046-6-355-668/000			355	
901006/66-953-2046-6-500-668/000			500	

Probes for operating medium water and oil

Note: Due to the response accuracy, use is only permitted without pockets (thermowells).

Actual type designation	Probe type	Temperature range	Nom. length mm	Process connection
RTD temperature probe Data Sheet 902006				
902006/10-402-1003-1-9-100-104/000	1 x Pt100	-40 ... +400°C	100	G1/2 compression clamp
902006/10-402-2003-1-9-100-104/000	2 x Pt100		100	
902006/54-227-2003-1-15-710-254/000	2 x Pt100	-170 ... 550°C	65...670	movable G1/2 compression clamp
902006/54-227-1003-1-15-710-254/000	1 x Pt100		65...670	

JUMO GmbH & Co. KG
 Delivery address: Mackenrodtstraße 14
 36039 Fulda, Germany
 Postal address: 36035 Fulda, Germany
 Phone: +49 661 6003-0
 Fax: +49 661 6003-607
 Email: mail@jumo.net
 Internet: www.jumo.net

JUMO Instrument Co. Ltd.
 JUMO House
 Temple Bank, Riverway
 Harlow, Essex, CM20 2DY, UK
 Phone: +44 1279 63 55 33
 Fax: +44 1279 62 50 29
 Email: sales@jumo.co.uk
 Internet: www.jumo.co.uk

JUMO Process Control, Inc.
 6724 Joy Road
 East Syracuse, NY 13057, USA
 Phone: +1 315 437 5866
 Fax: +1 315 437 5860
 Email: info.us@jumo.net
 Internet: www.jumousa.com



902006/10-226-1003-1-9-250-104/000	1 x Pt100	-170 ... 480°C	250	G1/2 compression clamp
902006/10-226-2003-1-9-250-104/000	2 x Pt100		250	
902006/10-402-1003-1-9-100-104/000	1 x Pt100	-40 ... +400°C	100	G1/2 compression clamp
902006/10-402-2003-1-9-100-104/000	2 x Pt100		100	G1/2 compression clamp
902006/10-402-1003-1-9-150-104/000	1 x Pt100		150	G1/2 compression clamp
902006/10-402-2003-1-9-150-104/000	2 x Pt100		150	G1/2 compression clamp
902006/10-402-1003-1-9-200-104/000	1 x Pt100		200	G1/2 compression clamp
902006/10-402-2003-1-9-200-104/000	2 x Pt100		200	G1/2 compression clamp
Thermocouples Data Sheet 901006				
901006/54-544-2043-15-710-254/000	2 x NiCr-Ni, Typ „K“	-35 ... 550°C	65...670	movable G1/2 compression clamp
901006/54-544-1043-15-710-254/000	1 x NiCr-Ni, Typ „K“		65...670	
901006/54-544-2042-15-710-254/000	2 x FeCuNi, Typ „L“		65...670	
901006/54-544-1042-15-710-254/000	1 x FeCuNi, Typ „L“		65...670	

Note:

Due to the response accuracy, use **is only permitted with thermowells** (immersion sleeves) **supplied by the factory.**

Actual type designation	Probe type	Temperature range	Nom. length mm	Process connection
RTD temperature probe Data Sheet 902006				
902006/53-505-2003-1-12-190-815/000	2 x Pt100	-40 ... +400 °C	190	welding sleeve
902006/53-507-2003-1-12-100-815/000	2 x Pt100 (arranged one below the other in the protection tube)	-40 ... +480 °C	100	welding sleeve
902006/53-507-2003-1-12-160-815/000			160	
902006/53-507-2003-1-12-190-815/000			190	
902006/53-507-2003-1-12-220-815/000			220	
902006/53-507-1003-1-12-100-815/000	1 x Pt100	-40 ... +480 °C	100	welding sleeve
902006/53-507-1003-1-12-160-815/000			160	
902006/53-507-1003-1-12-220-815/000			220	
902006/53-505-1003-1-12-190-815/000	1 x Pt100	-40 ... +400 °C	190	welding sleeve
902006/53-505-3003-1-12-100-815/000	3 x Pt100	-40 ... +400 °C	100	welding sleeve
902006/53-505-3003-1-12-160-815/000			160	
902006/53-505-3003-1-12-220-815/000			220	
902006/40-226-1003-1-12-220-815/000	1 x Pt100	-170 ... +480°C	220	welding sleeve
902006/40-226-1003-1-12-160-815/000			160	
902006/40-226-1003-1-12-100-815/000			100	
Thermocouples Data Sheet 901006				
901006/53-543-1042-12-220-815/000	1 x Fe-CuNi Typ „L“	-35 ... 480°C	220	welding sleeve
901006/53-543-2042-12-220-815/000	2 x Fe-CuNi Typ „L“		220	

Probes for the operating medium air, water, and oil

Note: Due to the response accuracy, use **is only permitted without pockets** (thermowells).

Actual type designation	Probe type	Temperature range	Install. length mm	Process connection
RTD temperature probe Data Sheet 902006				
902006/10-390-1003-1-8-250-104/000	1 x Pt100	max. 300°C	250	G1/2 compression clamp
Thermocouples Data Sheet 901006				connection line AL in mm
901006/45-551-2043-2-EL-11-AL/000	2 x NiCr-Ni, Typ „K“	max. 1150°C	50...2000	1000...20000

JUMO GmbH & Co. KG
 Delivery address: Mackenrodtstraße 14
 36039 Fulda, Germany
 Postal address: 36035 Fulda, Germany
 Phone: +49 661 6003-0
 Fax: +49 661 6003-607
 Email: mail@jumo.net
 Internet: www.jumo.net

JUMO Instrument Co. Ltd.
 JUMO House
 Temple Bank, Riverway
 Harlow, Essex, CM20 2DY, UK
 Phone: +44 1279 63 55 33
 Fax: +44 1279 62 50 29
 Email: sales@jumo.co.uk
 Internet: www.jumo.co.uk

JUMO Process Control, Inc.
 6724 Joy Road
 East Syracuse, NY 13057, USA
 Phone: +1 315 437 5866
 Fax: +1 315 437 5860
 Email: info.us@jumo.net
 Internet: www.jumousa.com



Safety control and regulating devices

Safety temperature monitor STW¹

The safety temperature monitor is a device that is automatically reset when activated once the sensor temperature has fallen below or risen above the set limit value by an amount equal to the switching differential. Possible settings: monitoring for limit value overrange or underrange.

Mode of operations:

Minimum requirements: 2B, 2K, 2P

Additional requirements: 2N, 2D

Safety temperature limiter STB¹

The safety temperature limiter is a device that is permanently locked after responding.

Manual reset using the RESET key is possible once the probe temperature has fallen below / has exceeded the limit value by the amount of the switching differential. Possible settings: monitoring for overrange or underrange.

Mode of operations:

Minimum requirements: 2B, 2J, 2V, 2K, 2P and adjustable with special tools

Additional requirements: 2N, 2F, 2D

¹: For more detailed explanation, see DIN EN 14 597.

Connection possibilities of the sensors (SIL)

The JUMO safetyM STB/STW 701150 evaluation device structure is basically identical. Various possibilities to connect the sensors are available. These possibilities are listed in the following table along with the achievable SIL level:

Variant	Connected sensors	Architecture		Achievable SIL			
		Sensor system	Logics				
1	1 x Pt100 in 2-wire circuit individual sensor	1oo1	1oo2D	2			
1a	2x Pt100/1000 2-wire circuit	1oo2	1oo2D	3			
2	2x Pt100/1000 3-wire circuit	1oo2	1oo2D	3			
3	2x thermocouple	1oo2	1oo2D	3			
4	1x Pt100/1000 2-wire and 3-wire circuit 1x thermocouple	1oo2	1oo2D	3			
5	STB/STW 70.1150 without sensor system 1oo2D architecture no probe or use 4 to 20 mA (means that the sensor is not taken into account for the calculation).	Sensors connected by the system user Architecture acc. to connection 1oo1 or 1oo2	1oo2D	SIL of the used sensor (HW only)	The systematic capability (SC) of the used sensor	Max. achievable SIL of the system with 1oo1 sensor system architecture	Max. achievable SIL of the system with 1oo2 sensor system architecture
				1	1	1	1
				1	2	1	2
				2	2	2	2
				2	3	2	3
3	3	3	3				

Note:

Variants 1 to 4 were evaluated with JUMO probes according to data sheets 901006 and 902006. For variant 5 no sensor system was taken into account. In this case, the user selects the sensor system. For this reason, the user is responsible for evaluating the achievable SIL.

If the used SIL-capable sensor consists of hardware and software (e.g. transmitter), the maximum SIL that can be achieved — irrespective of the architecture — is the one according to which the sensor software was developed (so, for example, if the sensor software has SIL 2, the max. achievable SIL is 2).

The possibility to connect passive sensors such as double thermocouples, Pt100, or Pt1000 sensors means that the sensors do not necessarily require a SIL qualification. In this case, the specification of the failure rates for the passive sensors is sufficient for the SIL qualification of the overall system. The user of the system must always determine the PFD_{avg} and/or PFH value of the overall safety circuit to evaluate the achieved SIL.

JUMO GmbH & Co. KG
 Delivery address: Mackenrodtstraße 14
 36039 Fulda, Germany
 Postal address: 36035 Fulda, Germany
 Phone: +49 661 6003-0
 Fax: +49 661 6003-607
 Email: mail@jumo.net
 Internet: www.jumo.net

JUMO Instrument Co. Ltd.
 JUMO House
 Temple Bank, Riverway
 Harlow, Essex, CM20 2DY, UK
 Phone: +44 1279 63 55 33
 Fax: +44 1279 62 50 29
 Email: sales@jumo.co.uk
 Internet: www.jumo.co.uk

JUMO Process Control, Inc.
 6724 Joy Road
 East Syracuse, NY 13057, USA
 Phone: +1 315 437 5866
 Fax: +1 315 437 5860
 Email: info.us@jumo.net
 Internet: www.jumousa.com



Failure rates and SFF for 701150...23 (AC 240 V)

Variant	λ_s [Fit]	λ_{dd} [Fit]	λ_{du} [Fit]	SFF	PFH (1/h)	PFD _{avg}
1	865.21	306.24	32.31	96 %	4.56 e ⁻⁹	2.02 e ⁻⁴
1a	865.21	306.24	32.31	96 %	1.05 e ⁻⁹	4.57 e ⁻⁵
2	868.17	303.28	32.31	96 %	1.05 e ⁻⁹	4.57 e ⁻⁵
3	881.62	326.78	33.62	96 %	1.03 e ⁻⁹	4.49 e ⁻⁵
4	887.68	343.82	35.52	96 %	1.22 e ⁻⁹	5.30 e ⁻⁵
5	881.02	313.43	35.57	96 %	1.04 e ⁻⁹	4.48 e ⁻⁵

Failure rates and SFF for 701150...25 (AC/DC 24 V)

Variant	λ_s [Fit]	λ_{dd} [Fit]	λ_{du} [Fit]	SFF	PFH (1/h)	PFD _{avg}
1	799.3	306.32	33.61	96 %	6.59 e ⁻⁹	2.91 e ⁻⁴
1a	799.3	306.32	33.61	96 %	3.07 e ⁻⁹	1.35 e ⁻⁴
2	802.26	303.36	33.61	96 %	3.07 e ⁻⁹	1.35 e ⁻⁴
3	827.25	324.71	37.91	96 %	3.13 e ⁻⁹	1.37 e ⁻⁴
4	833.31	341.75	39.81	96 %	3.23 e ⁻⁹	1.41 e ⁻⁴
5	818.96	323.07	36.26	96 %	3.05 e ⁻⁹	1.33 e ⁻⁴

Note:

Variants 1 to 4 were evaluated with JUMO probes according to data sheets 901006 and 902006.

For variant 5 no sensor system was taken into account. In this case, the user selects the sensor system.

The PFH and PFD_{avg} values were calculated assuming that the time to restore the system is 8 h (MTTR = 72 h). Furthermore, the calculation was based on a lifetime of 10 years (T₁ = 10 y). The Common Cause Factor was determined according to the tables of DIN EN 61508 for sensor systems and logic.

Calculations DIN EN ISO 13849-1 Performance Level - low voltage 230 V

Variant	MTTF _d	DC _{avg}	CCF	PL
1	100 years ³ (337 years)	90 %	80	PLd
1a	100 years ³ (337 years)	90 %	80	PLe
2	100 years ³ (340 years)	90 %	80	PLe
3	100 years ³ (317 years)	91 %	80	PLe
4	100 years ³ (313 years)	91 %	80	PLe
5	100 years ³ (327 years)	91 %	80	See "Connection possibilities of the sensors" table

Calculations DIN EN ISO 13849-1 Performance Level - extra low voltage (ELV) 24 V

Variant	MTTF _d	DC _{avg}	CCF	PL
1	100 years ³ (336 years)	90 %	80	PLd
1a	100 years ³ (336 years)	90 %	80	PLe
2	100 years ³ (339 years)	90 %	80	PLe
3	100 years ³ (315 years)	90 %	80	PLe
4	100 years ³ (311 years)	90 %	80	PLe
5	100 years ³ (318 years)	90 %	80	See "Connection possibilities of the sensors" table

3. The MTTF_d value of a partial system must be limited to 100 years according to the DIN EN ISO 13849-1 requirements.

Scope of delivery

- 1 JUMO safetyM STB/STW in ordered version
- 1 operating manual

JUMO GmbH & Co. KG
 Delivery address: Mackenrodtstraße 14
 36039 Fulda, Germany
 Postal address: 36035 Fulda, Germany
 Phone: +49 661 6003-0
 Fax: +49 661 6003-607
 Email: mail@jumo.net
 Internet: www.jumo.net

JUMO Instrument Co. Ltd.
 JUMO House
 Temple Bank, Riverway
 Harlow, Essex, CM20 2DY, UK
 Phone: +44 1279 63 55 33
 Fax: +44 1279 62 50 29
 Email: sales@jumo.co.uk
 Internet: www.jumo.co.uk

JUMO Process Control, Inc.
 6724 Joy Road
 East Syracuse, NY 13057, USA
 Phone: +1 315 437 5866
 Fax: +1 315 437 5860
 Email: info.us@jumo.net
 Internet: www.jumousa.com



Order details

(1) model	
701150	Safety temperature limiter / monitor
(2) configuration	
8	with factory settings
9	with customer settings
(3) language	
01	German
02	English
03	French
(4) basic type extension	
0251	Safety temperature monitor (O-function)
0252	Safety temperature monitor (N.O.-function)
0253	Safety temperature limiter (O-function)
0254	Safety temperature limiter (N.O.-funct.)
(5) measuring input	
1003	1x Pt100 2-wire
1053	1x 4..20mA
2001	2x Pt100 3-wire
2003	2x Pt100 2-wire
2005	2x Pt1000 2-wire
2006	2x Pt1000 3-wire
2036	2x W5Re-W26Re "C"
2037	2x W3Re-W25Re "D"
2039	2x Cu-CuNi "T"
2040	2x Fe-CuNi "J"
2041	2x Cu-CuNi "U"
2042	2x Fe-CuNi "L"
2043	2x NiCr-Ni "K"
2044	2x Pt10Rh-Pt "S"
2045	2x Pt13Rh-Pt "R"
2046	2x Pt30Rh-Pt6Rh "B"
2048	2x NiCrSi-NiSi "N"
2053	2x 4..20mA
(6) Voltage supply	
23	AC 110..240V +10/-15%,48..63Hz
25	AC/DC 20..30V,48..63Hz
(7) output	
001	0..20mA analog
005	4..20mA analog
040	0..10V analog
070	2..10V analog
(8) GL approval	
000	without approval
062	with DNV approval
(9) extra code	
000	without approval
058	with SIL- and PL-approval (yellow front foil)

Order code

(1) (2) (3) (4) (5) (6) (7) (8) (9)

/ - - - / ,

Accessories

Article	Part no.
Setup program, multilingual	00548742
USB cable	00506252
External unlocking button RT	97097865