

MRD-6A-G

MAGNETIC SENSOR
ABSOLUTE ENCODER
 Gray Code
 Binary Code



- Output Code 碼值: Gray Code 格雷碼
Binary Code 二進制
- High Resolution 高解析值: 12 bit
- Application 適合: 角度 Angle、位置 Position
張力 Tension、速度 Speed

DIMENSION

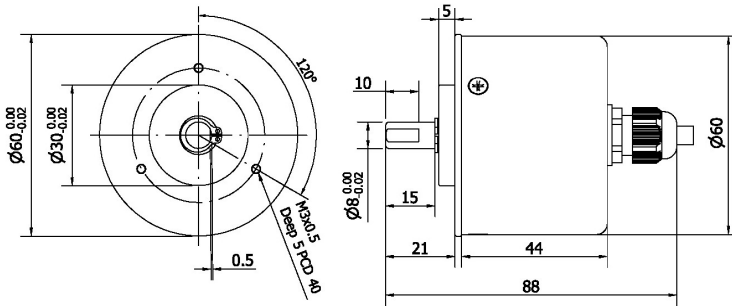

ORDERING INFORMATION

MRD-6A-		- 4096 -		-	
	Code 碼值	Signal 輸出信號	Electronics 電路特性	Signal Sequence 信號輸出序列	
	G: Gray	4096	V5: NPN Voltage 5V	*W: Reversed	
	B: Binary	(Std. Sequence)	V8: NPN Voltage 8~26V		
			C: NPN Open Collector 5~26V	* OPTION	

ELECTRICAL SPEC.

Detection System	Absolute 絕對值
Output Code 輸出碼值	Gray Code 格雷碼, Binary Code 二進制
Std. Pulse Per Revolution 解析	[standard]12 bit (0~4096) (increasing); [option] 12 bit (4096~0) (decreasing)
Electronics 電路特性	NPN Voltage 電壓型, NPN Open Collector 電流型
Power Supply 供應電源	DC 5V, DC8~26V for NPN Voltage; DC 5~26V for NPN Open Collector
Logic 邏輯	Negative Logic (H=0, L=1) 負理論輸出
Current Consumption 消耗電流	≤ 80 mA (no load)
Output Capacity 輸出容量	20 mA for NPN Voltage, max. 30 mA for NPN Open Collector, Residual Voltage 1V or less
Max. Response 最大響應頻率	50K Hz
Duty	50 +/- 10%
Insulation Strength 耐壓強度(Vrms)	1KV / min.
Insulation Resistance 絕緣阻抗(MΩ min.)	100 MΩ / 500 Vdc
Wave Form Rise / Fall 波形上下時間	2 μs or less
Polarity 極性保護	Against Reverse Protection

MECHANICAL SPEC.

Shaft Diameter 軸徑	8 mm
Shaft Loading 軸荷重	Axial 軸向: 4 Kg, Radial 徑向: 8 Kg
Starting Torque (at 25°C) 起動轉矩	260 gf-cm or less
Mechanical Angle 機械迴轉角度	360° continuous 連續
Mechanical Life 機械迴轉壽命	1X10 ⁹ cycles
Max. Speed 最大容許旋轉速度	600 rpm
Vibration 震動	10-55 Hz / 1.5 mm Vpp / 10 G (max.)
Shock 衝擊	50g per 11 ms
Cable 電線	Ø7, 1000 mm long
Weight 重量	≤ 320g

ENVIRONMENTAL SPEC.

Operating Temp. / Humidity 操作溫度/濕度	-10°C ~ 70°C, RH 35% ~ 90% (No Condensation)
Storage Temp. 儲存溫度	-20°C ~ 80°C
Protection 保護等級	IP64: Dust & Dripping Proof

MRD-6A-G

MAGNETIC ENCODER

ABSOLUTE

GRAY CODE



- Output Code 碼值: Gray Code 格雷碼
Binary Code 二進制
- High Resolution 高解析值: 12 bit
- Application 適合: 角度 Angle、位置 Position
張力 Tension、速度 Speed

Gray Code

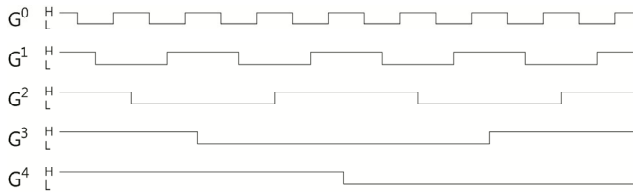

POSITION	2 ⁴	2 ³	2 ²	2 ¹	2 ⁰
0	0	0	0	0	0
1	0	0	0	0	1
2	0	0	0	1	1
3	0	0	0	1	0
4	0	0	1	1	0
5	0	0	1	1	1
6	0	0	1	0	1
7	0	0	1	0	0
8	0	1	1	0	0
9	0	1	1	0	1
10	0	1	1	1	1
11	0	1	1	1	0
12	0	1	0	1	0
13	0	1	0	1	1
14	0	1	0	0	1
15	0	1	0	0	0

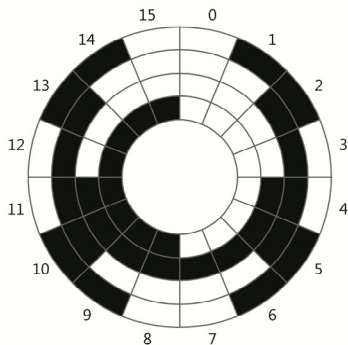

Binary Code

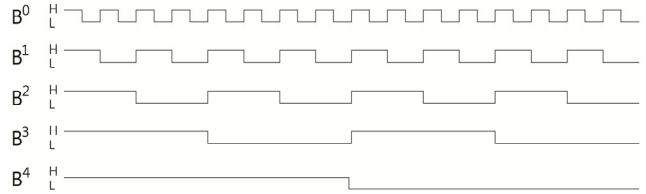

POSITION	2 ⁴	2 ³	2 ²	2 ¹	2 ⁰
0	0	0	0	0	0
1	0	0	0	0	1
2	0	0	0	1	0
3	0	0	0	1	1
4	0	0	1	0	0
5	0	0	1	0	1
6	0	0	1	1	0
7	0	0	1	1	1
8	0	1	0	0	0
9	0	1	0	0	1
10	0	1	0	1	0
11	0	1	0	1	1
12	0	1	1	0	0
13	0	1	1	0	1
14	0	1	1	1	0
15	0	1	1	1	1

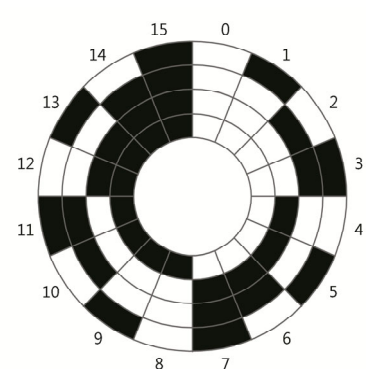

Electrical Connection

WIRE FUNCTION	4096	2048	1024	512	256	128	64	32	16	8	4	2
RED 紅	+V	+V	+V	+V	+V	+V	+V	+V	+V	+V	+V	+V
BLK 黑	0V	0V	0V	0V	0V	0V	0V	0V	0V	0V	0V	0V
BLU 藍	Bit 1 (2 ⁰)											
BLU/WHT 藍/白	Bit 2 (2 ¹)	Bit 1 (2 ⁰)										
GRE 綠	Bit 3 (2 ²)	Bit 2 (2 ¹)	Bit 1 (2 ⁰)									
GRE/WHT 綠/白	Bit 4 (2 ³)	Bit 3 (2 ²)	Bit 2 (2 ¹)	Bit 1 (2 ⁰)								
YEL 黃	Bit 5 (2 ⁴)	Bit 4 (2 ³)	Bit 3 (2 ²)	Bit 2 (2 ¹)	Bit 1 (2 ⁰)							
YEL/BLK 黃/黑	Bit 6 (2 ⁵)	Bit 5 (2 ⁴)	Bit 4 (2 ³)	Bit 3 (2 ²)	Bit 2 (2 ¹)	Bit 1 (2 ⁰)						
PPL 紫	Bit 7 (2 ⁶)	Bit 6 (2 ⁵)	Bit 5 (2 ⁴)	Bit 4 (2 ³)	Bit 3 (2 ²)	Bit 2 (2 ¹)	Bit 1 (2 ⁰)					
PPL/WHT 紫/白	Bit 8 (2 ⁷)	Bit 7 (2 ⁶)	Bit 6 (2 ⁵)	Bit 5 (2 ⁴)	Bit 4 (2 ³)	Bit 3 (2 ²)	Bit 2 (2 ¹)	Bit 1 (2 ⁰)				
ORN 橙	Bit 9 (2 ⁸)	Bit 8 (2 ⁷)	Bit 7 (2 ⁶)	Bit 6 (2 ⁵)	Bit 5 (2 ⁴)	Bit 4 (2 ³)	Bit 3 (2 ²)	Bit 2 (2 ¹)	Bit 1 (2 ⁰)			
ORN/WHT 橙/白	Bit 10 (2 ⁹)	Bit 9 (2 ⁸)	Bit 8 (2 ⁷)	Bit 7 (2 ⁶)	Bit 6 (2 ⁵)	Bit 5 (2 ⁴)	Bit 4 (2 ³)	Bit 3 (2 ²)	Bit 2 (2 ¹)	Bit 1 (2 ⁰)		
BRN 棕	Bit 11 (2 ¹⁰)	Bit 10 (2 ⁹)	Bit 9 (2 ⁸)	Bit 8 (2 ⁷)	Bit 7 (2 ⁶)	Bit 6 (2 ⁵)	Bit 5 (2 ⁴)	Bit 4 (2 ³)	Bit 3 (2 ²)	Bit 2 (2 ¹)	Bit 1 (2 ⁰)	
BRN/WHT 棕/白	Bit 12 (2 ¹¹)	Bit 11 (2 ¹⁰)	Bit 10 (2 ⁹)	Bit 9 (2 ⁸)	Bit 8 (2 ⁷)	Bit 7 (2 ⁶)	Bit 6 (2 ⁵)	Bit 5 (2 ⁴)	Bit 4 (2 ³)	Bit 3 (2 ²)	Bit 2 (2 ¹)	Bit 1 (2 ⁰)

Output Signal

NPN Voltage

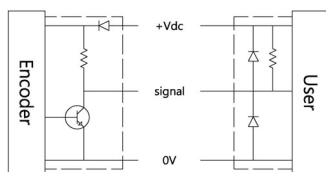

NPN Open Collector

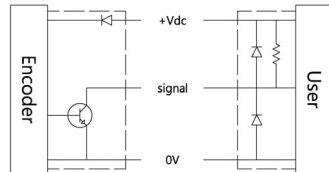

Output Curve

E.S.E.有效電子角度	360°
Accuracy 精度	±0.20%FS
Repeatability Error 重覆性誤差	±0.08%FS

