

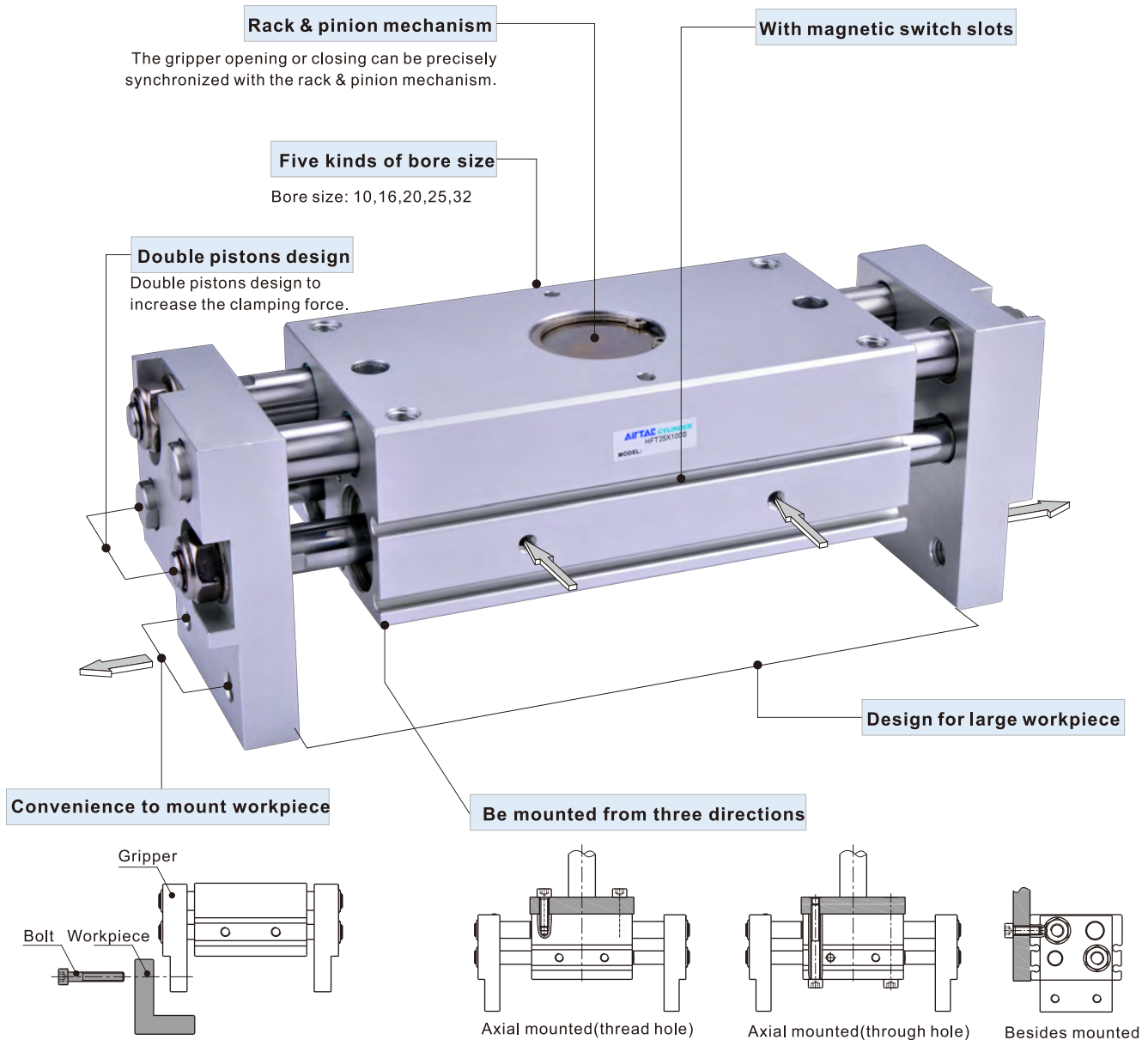

Wide air gripper—HFT Series

Compendium of HFT Series



Air gripper(wide style)

HFT Series



Symbol

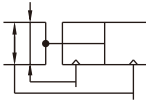

Product feature

1. Design for large workpiece.
2. Double pistons design to increase the clamping force.
3. Magnet is included in the standard configuration.
4. The gripper opening or closing can be precisely synchronized with the rack & pinion mechanism.

Specification

Bore size (mm)	10	16	20	25	32
Acting type	Double acting				
Fluid	Air(to be filtered by 40μm filter element)				
Operating pressure	0.25~0.7MPa(35~100psi)		0.15~0.7MPa(22~100psi)		
Proof pressure	1.2MPa(175psi)				
Temperature	-20~70°C				
Lubrication	Cylinder : No necessary				
Cushion type	Bumper				
Repeatability	±0.1mm				
Gripping force (N)[Note1]	14	45	74	131	228
Max. frequency	40 cycle/minute				20 cycle/minute
Port size	M5×0.8				1/8"

[Note1] Pressure 0.5MPa and gripping length 40mm(∅10 ~ ∅25) or 80mm(∅32).

Add) Refer to P365 for detail of sensor switch.

Stroke

Bore size (mm)	Standard stroke (mm)	Max. stroke (mm)
10	20 30 40 60	60
16	30 40 60 80	80
20	40 60 80 100	100
25	40 60 80 100	100
32	60 80 100 150	150

[Note] Consult us for non-standard stroke.

Ordering code

HFT 10 × 20 S □

① ② ③ ④ ⑤

① Model	② Bore size	③ Stroke	④ Magnet	⑤ Thread type
HFT: Wide air gripper (Double acting)	10	20 30 40 60	S: With magnet	No this code Blank: PT G: G T: NPT
	16	30 40 60 80		
	20	40 60 80 100		
	25	40 60 80 100		
	32	60 80 100 150		

Inner structure and material of major parts

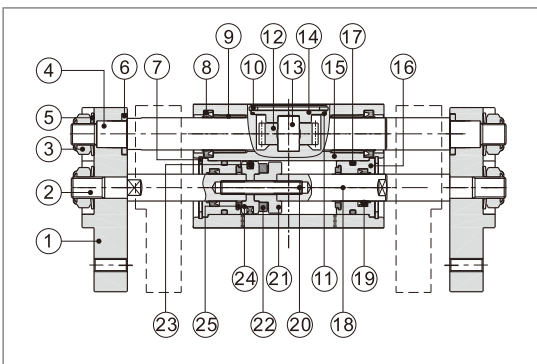

NO.	Item	Material	NO.	Item	Material
1	Faceplate	Aluminum alloy	14	Gear cover	Carbon steel
2	Piston rod A	Stainless steel	15	Body	Aluminum alloy
3	Locknut	Carbon steel	16	Front cover	Aluminum alloy
4	Leader	Stainless steel	17	O-ring	NBR
5	Washer	Spring steel	18	Piston rod B	Stainless steel
6	Gasket	Carbon steel	19	O-ring	NBR
7	C clip	Spring steel	20	Joint bolt	Stainless steel
8	Dustproof ring	TPU	21	Magnet seat	Brass/Aluminum alloy
9	Bearing	Wear resistant material	22	Magnet	Sintered metal (Neodymium-iron-boron)
10	C clip	Spring steel			
11	O-ring	NBR	23	Piston O-ring	NBR
12	Gear	Chrome molybdenum steel	24	Piston	Brass/Aluminum alloy
13	Gear axes	Bearing steel	25	Bumper	TPU

Air gripper(wide style)

HFT Series

Dimensions

HFT10

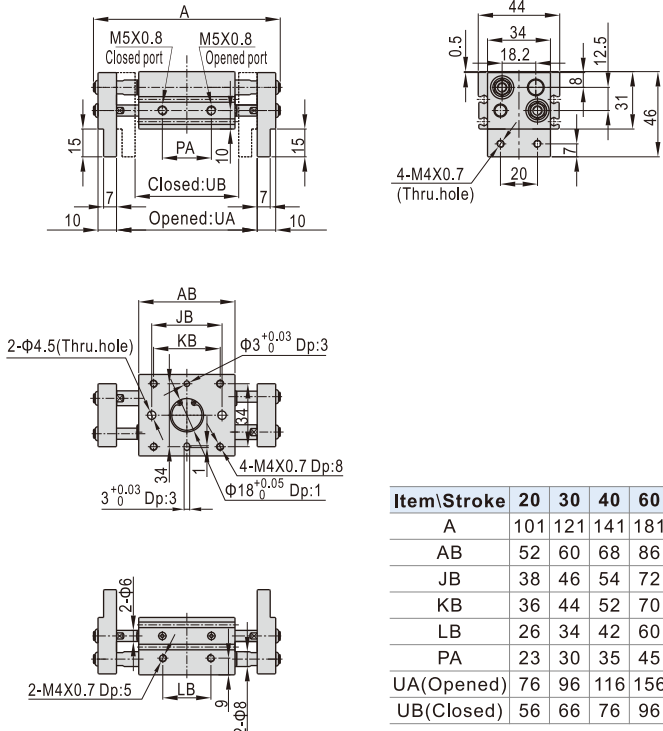

HFT16

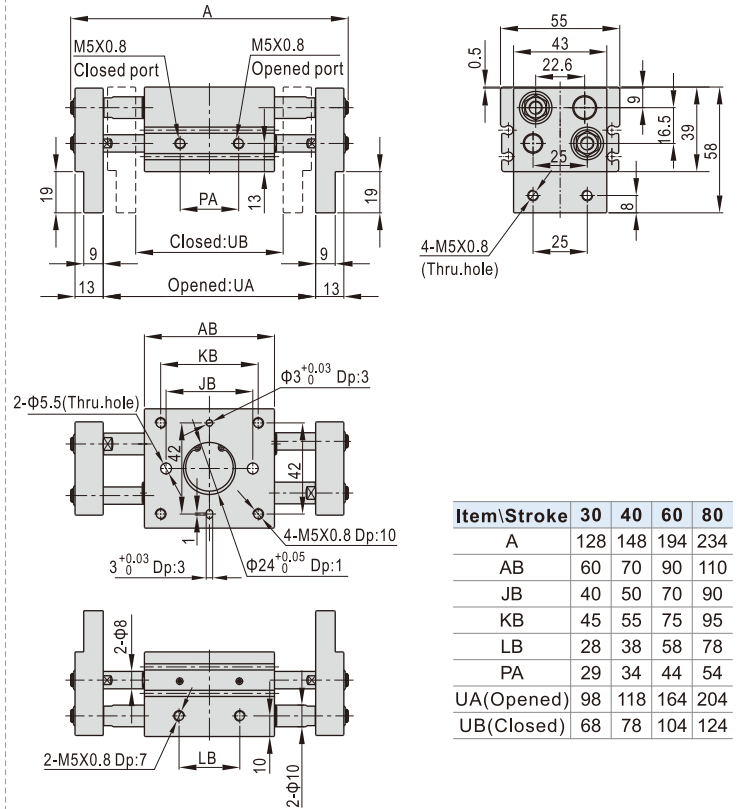

HFT20

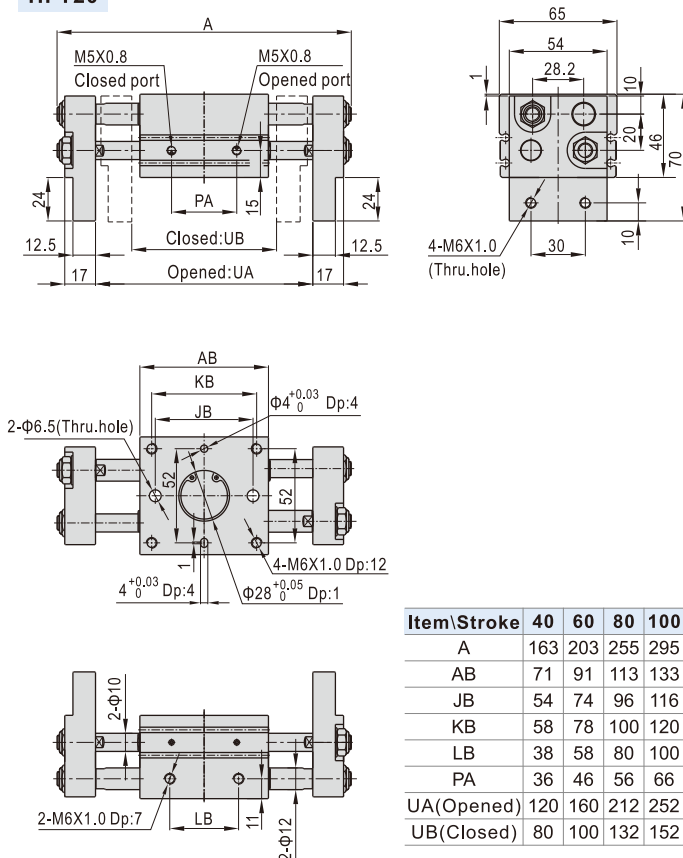

HFT25

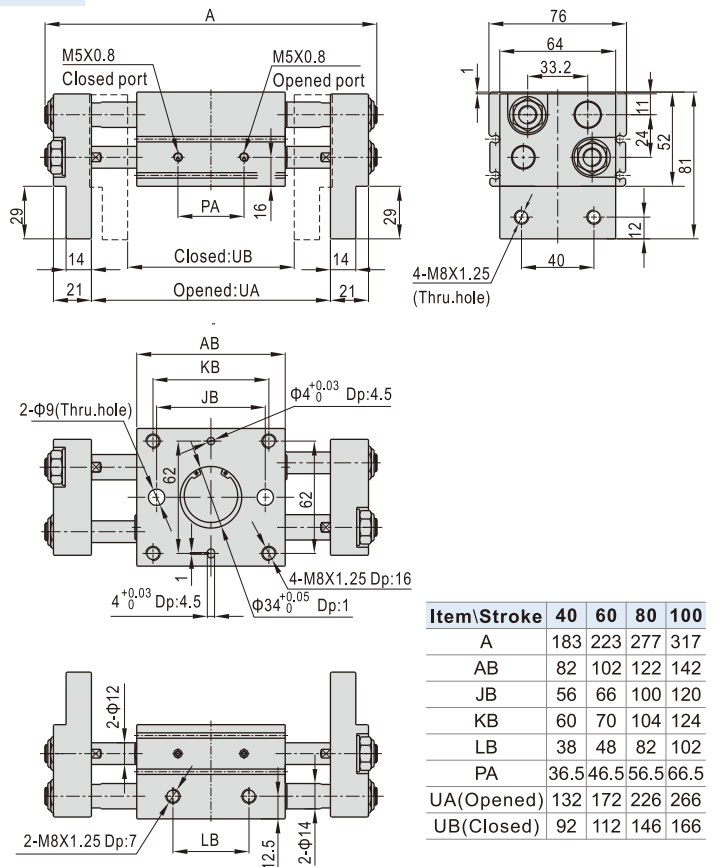

HFT32

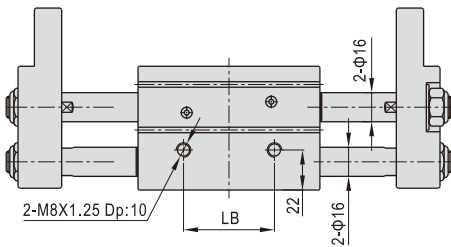
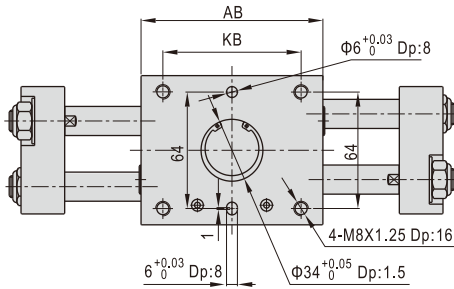
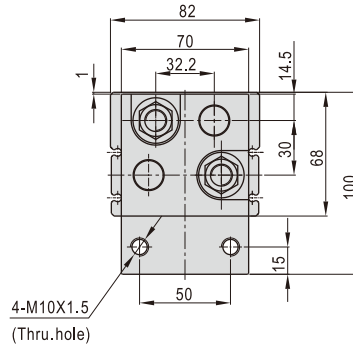
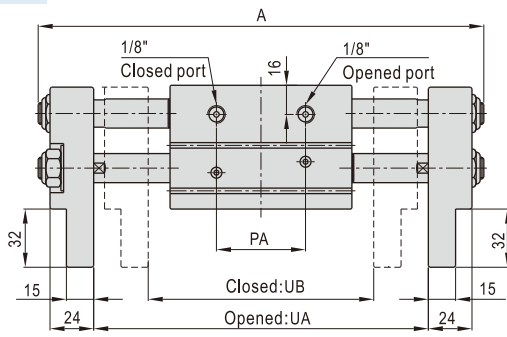

Item/Stroke	A	AB	KB	LB	PA	UA(Opened)	UB(Closed)
60	245	100	76	50	48	184	124
80	285	120	86	60	58	224	144
100	343	158	134	108	68	282	182
150	443	208	184	158	93	382	232

How to select product

1. Please select pneumatic finger according to the following steps:

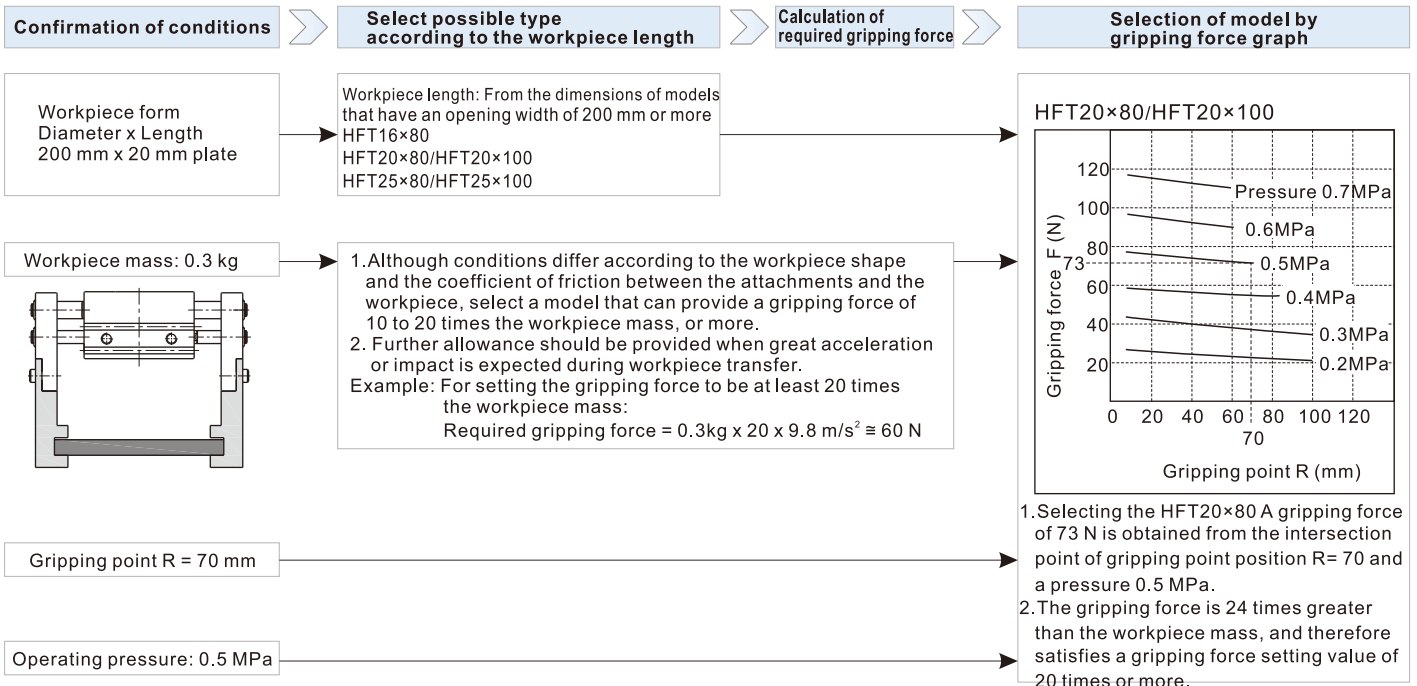

HFT Series

2. Gripping Point

- 2.1) The workpiece gripping point distance should be within the gripping force ranges given for each pressure in the effective gripping force graphs below.
- 2.2) If operated with the workpiece gripping point beyond the indicated ranges, the load that will be applied to the fingers or the guide will become excessively unbalanced. As a result, the fingers could become loosened and adversely affect the service life of the unit.

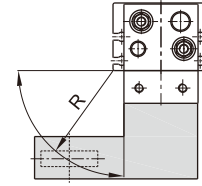
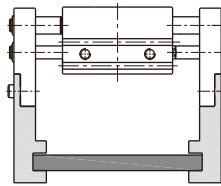

R: Gripping position (mm)

3. Effective Gripping Force

The gripping force shown in the tables represents the gripping force of one finger when all fingers and attachments are in contact with the work.

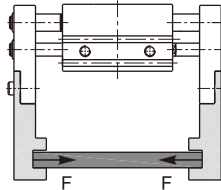

F = one finger thrust.

HFT10×20/HFT10×30

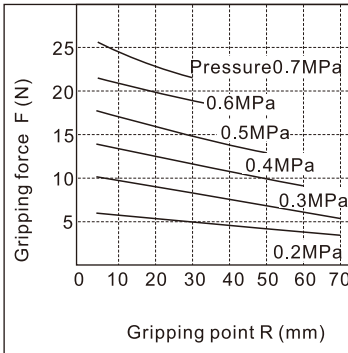

HFT10×40/HFT10×60

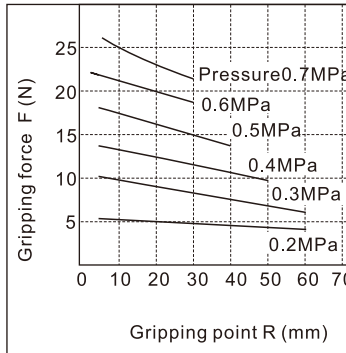

HFT16×30/HFT16×40

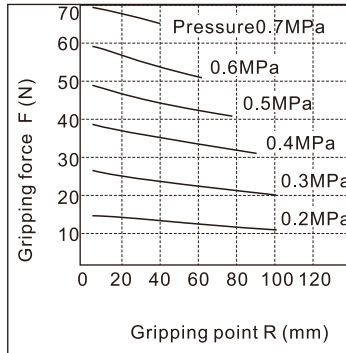

HFT16×60/HFT16×80

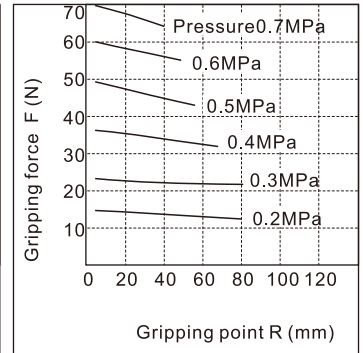

HFT20×40/HFT20×60

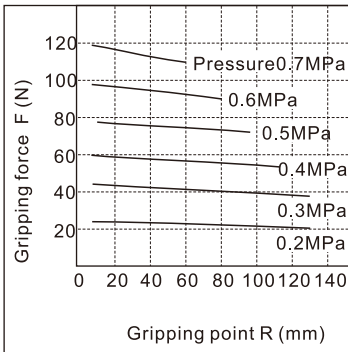

HFT20×80/HFT20×100

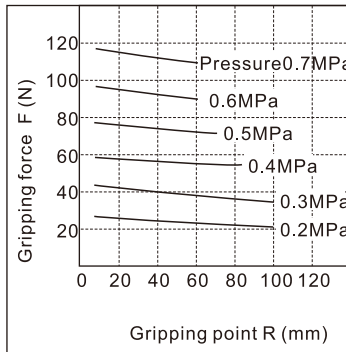

HFT25×40/HFT25×60

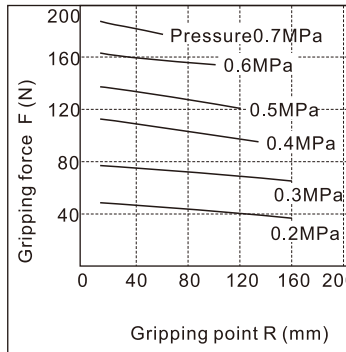

HFT25×80/HFT25×100

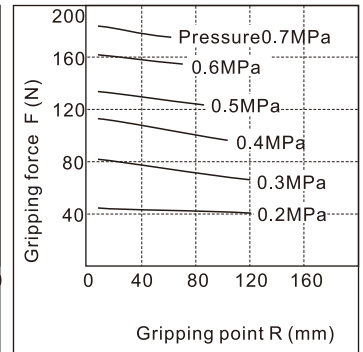

HFT32×60/HFT32×80

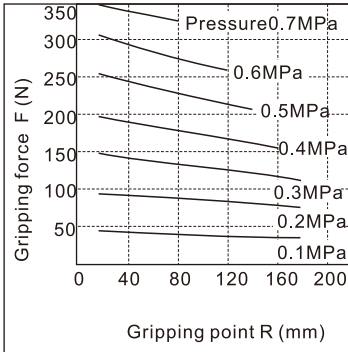

HFT32×100/HFT32×150

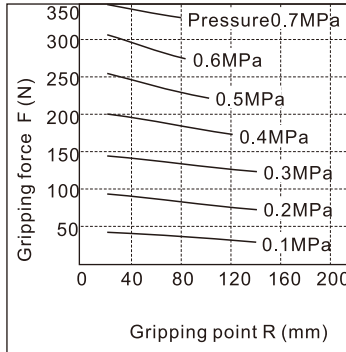

Installation and application

1. Due to the abrupt changes, the circuit pressure is low, which will lead to the decrease of the gripping force and falling of the work-pieces. In order to avoid the harm to the human body and damage to the equipment, anti-dropping device must be equipped.
2. Don't use the air gripper under strong external force and impact force.
3. When install and fix the air gripper, avoid falling down, collision and damage.
4. When fixing the gripping jaw parts, don't twist the gripping jaw.
5. There are several kinds of installation method, and the locking torque of fastening screw must be within the prescribed torque range shown in the below chart. If the locking torque is too large, it will cause the dysfunctional. If the locking torque is too small, it will cause the position deviation and fall.

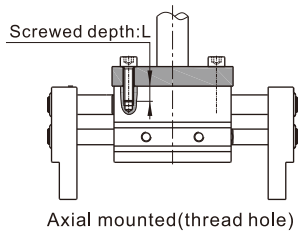

Axial mounted(thread hole)

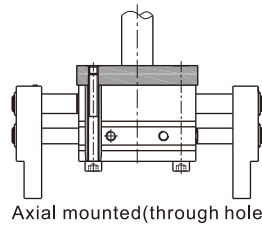

Axial mounted(through hole)

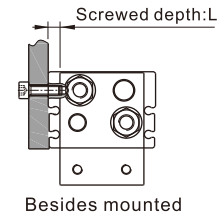

Besides mounted

Bore size	The bolts type	Max. locking moment (Nm)	Max. screwed depth (mm)
10	M4×0.7	2.1	8
16	M5×0.8	4.3	10
20	M6×1.0	7.3	12
25	M8×1.25	17.7	16
32	M8×1.25	17.7	16

Bore size	The bolts type	Max. locking moment (Nm)
10	M4×0.7	2.1
16	M5×0.8	4.3
20	M6×1.0	7.3
25	M8×1.25	17.7
32	No Axial mounted(through hole)	

Bore size	The bolts type	Max. locking moment (Nm)	Max. screwed depth (mm)
10	M4×0.7	1.4	5
16	M5×0.8	2.8	7
20	M6×1.0	4.8	7
25	M8×1.25	12	7
32	M8×1.25	12	10

6. The installation method of the gripping jaw fittings

When install the gripping jaw fittings, you have to pay particular attention that you can only hold the gripping jaw by using spanner, and then lock the screws with allen wrench. Never clamp the body directly and then lock the screws, otherwise the parts will be easily damaged.

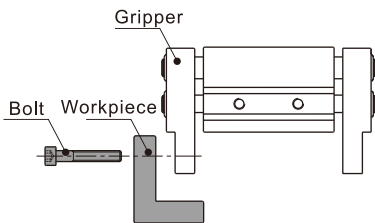

Bore size	The bolts type	Max. locking moment(Nm)
10	M4×0.7	1.4
16	M5×0.8	2.8
20	M6×1.0	4.8
25	M8×1.25	12
32	M10×1.5	24

7. Confirm that there is no external forces exerted on the gripping jaw.

Transverse load acts on the gripping jaw, which will cause impact load and leads to the shaking and damage of gripping jaw. Equip with gaps so that the air gripper will not crash into work-pieces and accessories at the end of its trip.

7.1) The end of stroke under the open state of air gripper

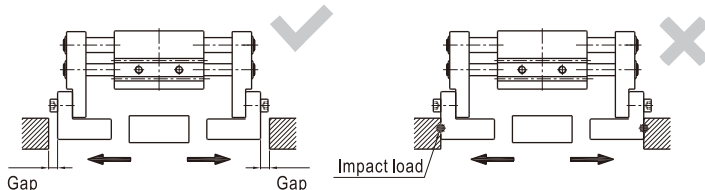

7.2) The end of stroke under the move state of air gripper

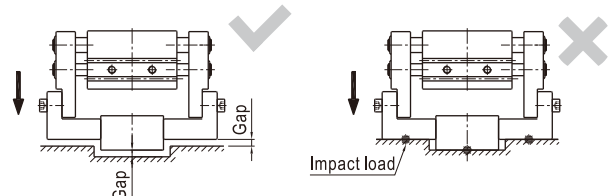

8. When the work-pieces are inserted, the center line should be coaxial, no offset, in case there are external force generated on gripping jaw. When testing, it is specially required that the manual operation should be reduced, the pressure should be used to run it at a low speed, and guarantee the safety and no impact.

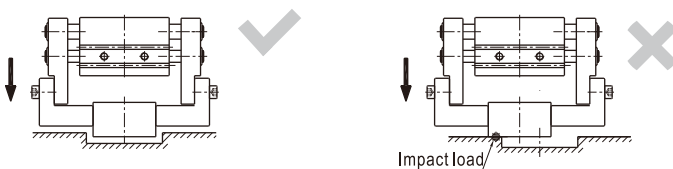

9. Please use the flow control valve to adjust the opening and closing speed of gripping jaw if too fast.

10. People can not enter the movement path of air gripper and articles can not be placed on the path too.

11. Before removing the air gripper, please confirm that it is out of working state, and then discharge of compressed air.