

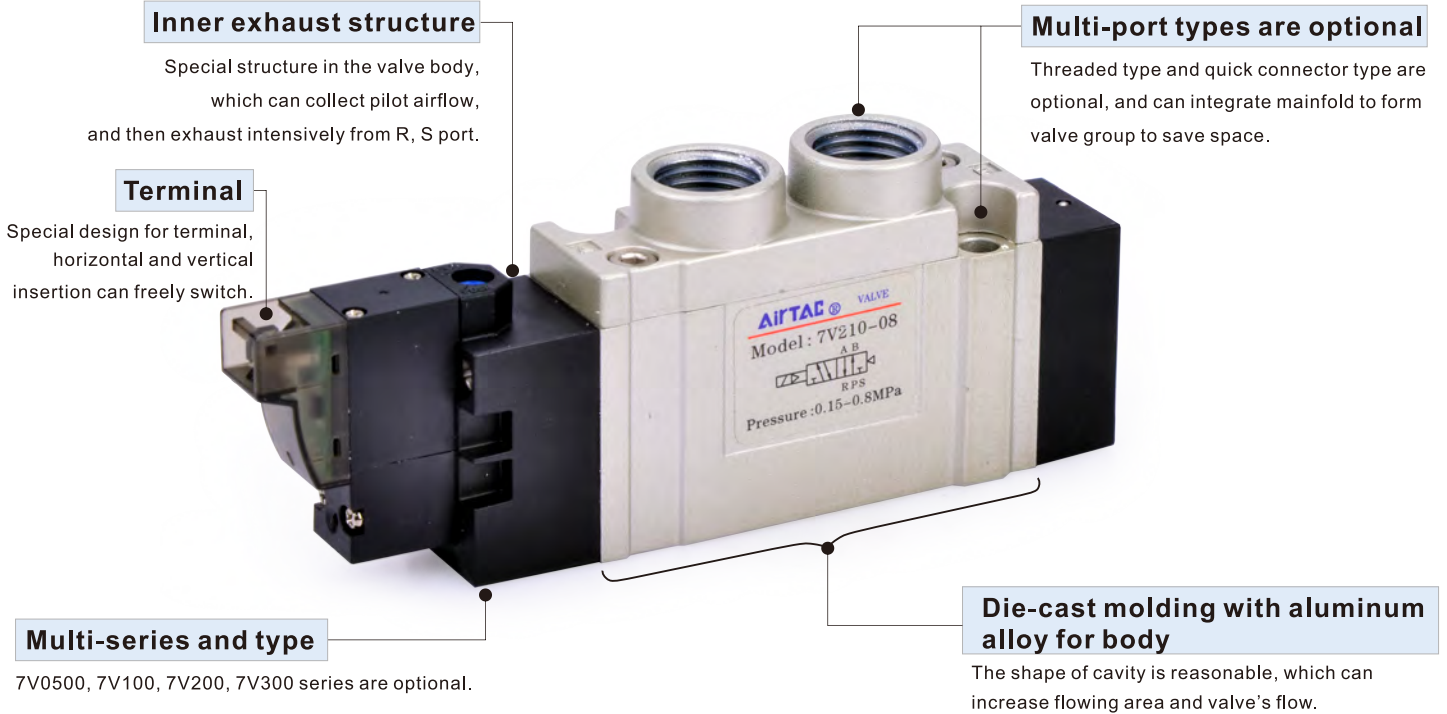

7V Series Solenoid valve(5/2 way,5/3 way)

Compendium of 7V Series



Installation and Application

1. Don't throw or drop the solenoid valve when take it, to avoid breaking valve;
2. Because solenoid pilot valve is sophisticated component, can't crash pilot valve by outside force, otherwise solenoid valve break possibly;
3. Don't dismantle solenoid valve freely, if the screw(M1.6X14) becomes loose, please tighten it by torque 0.1~0.12N.m;
4. About manual operation:
 - 4.1. Ensure no danger, prior to activating manual override;
 - 4.2. For push button option:
Activate by push the button in the direction shown
 - 4.3. For slotted option:
Activate by push the button in the direction shown.
With correct size screw driver: please turn to lock gently(Torque : 0.1N.m).

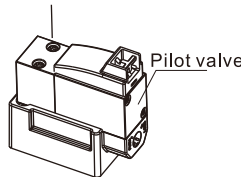

Attention



Normal position



Lucked position

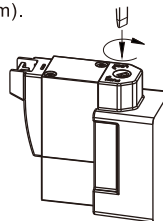

- 4.4. Wiring instruction : Vertical plug type and parallel plug type are the same as plug, please insert wire line as up drawing by practicality.



Vertical plug wire



Parallel plug wire

Solenoid valve(5/2 way,5/3 way)

7V Series



Specification

Model	7V0510	7V0520	7V0530	7V110	7V120	7V130
Port size [Note1]	Thread type			In=Out=Exhaust=M5		
	Tube type			In=Out=Exhaust=1/8"		
Orifice size (Cv) [Note4]	M5:3.4mm ² (0.2)		7V0530CM5: 2.2mm ² (0.13)	06:8.0mm ² (0.47)		7V130C06: 7.0mm ² (0.41)
	Weight	30g	45g	50g	80g	90g
Model	7V210	7V220	7V230	7V310	7V320	7V330
Port size [Note1]	Thread type			In=Out=1/4" Exhaust=1/8"		
	Tube type			In=Out=3/8" Exhaust=1/4"		
Orifice size (Cv) [Note4]	08:14.7mm ² (0.87)		7V230C08: 10.8mm ² (0.64)	10:38.4mm ² (2.26)		7V330C10: 30.5mm ² (1.8)
	Weight	120g	135g	145g	230g	265g
Fluid	Air(to be filtered by 40μm filter element)					
Acting	Pilot					
Operating pressure	7V0530/7V130 7V230/7V330			0.2~0.8MPa(29~114psi)		
	Others			0.15~0.8MPa(21~114psi)		
Proof pressure	1.2MPa(175psi)					
Temperature	-20~70°C					
Material of body	Aluminum alloy					
Lubrication [Note2]	Not required					
Exhaust type of pilot valve	Main valve and pilot valve is centralized exhaust					
Max. frequency[Note3]	5 cycle/sec	3 cycle/sec	3 cycle/sec	5 cycle/sec	3 cycle/sec	3 cycle/sec

- [Note1] PT, NPT thread and G thread are available.
 [Note2] Once lubricated air is used, continue with same medium to optimize valve life span. Lubricants like ISO VG32 or equivalent are recommended.
 [Note3] The maximum actuation frequency is in the no-load state.
 [Note4] Equivalent orifice S and Cv are all calculated from the flow rate data.

Symbol

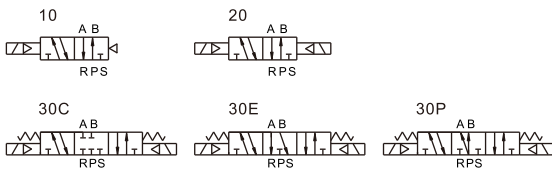

Product feature

- Electrical entry is terminal, horizontal and vertical insertion can freely switch.
- Inner exhaust structure, which can collect pilot airflow, and then exhaust intensively from R, S port.
- Die-cast molding with aluminum alloy for body. The shape of cavity is reasonable, which can increase valve's flow.
- Threaded type and quick connector type are optional, and can integrate manifold to form valve group to save space.

Coil specification

Item	Specification			
Standard voltage	AC220V	AC110V	DC24V	DC12V
Scrop of voltage	AC : +15% ~-10%		DC : ±10%	
Power of consumption	1.1VA		0.9W	
Protection	Dustproof			
Temperature classification	F Class			
Electrical entry	Terminal			
Activating time	0.05 sec and below			

Ordering code

7V 2 10 J 08 B 050 □



① Model	7V: 5 port 2(3) position solenoid valve					
② Code	05: 0500 Series	1: 100 Series	2: 200 Series	3: 300 Series		
③ Valve type	10 : Single solenoid(5/2 Way)		20 : Double solenoid(5/2 Way)		30C : Double solenoid(5/3 way closed center)	
	30E : Double solenoid(5/3 way Exhaust center)		30P : Double solenoid(5/3 way pressure center)			
④ Port type	Blank : Thread type J : Tube type					
⑤ Port size	Thread type		M5: M5	06: 1/8"	08: 1/4"	10: 3/8"
	Tube type		04: Φ4mm	04: Φ4mm/06: Φ6mm/08: Φ8mm	08: Φ8mm/10: Φ10mm	-
⑥ Voltage	A: AC220V B: DC24V C: AC110V F: DC12V					
⑦ Wire length	050: 0.5m 200: 2.0m					
⑧ Thread type	No this code	Blank : PT thread	G : G Thread	T : NPT Thread		

[Note 1]: The bottom ports of solenoid valve with tube type are oval, without thread type options and can only install with a manifold.

Flow chart

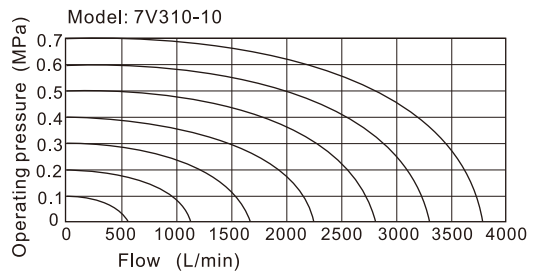
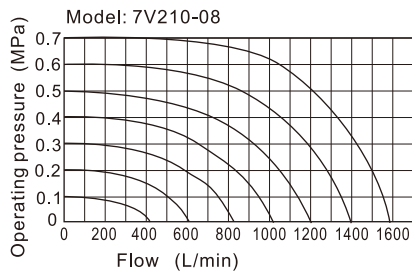
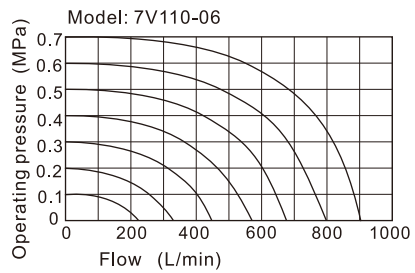
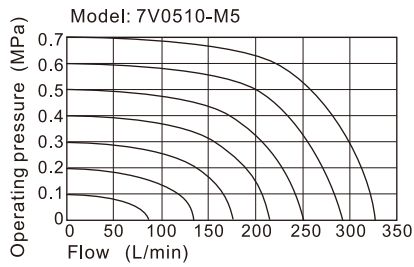

The data in flow rate chart are obtained from AirTAC lab.

Inner structure

7V110

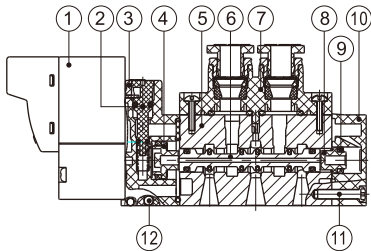

7V120

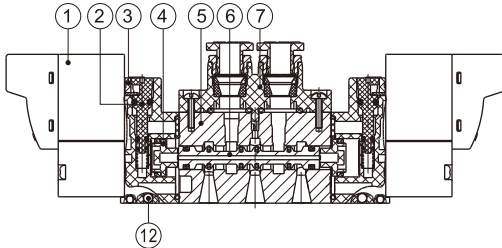

7V130C

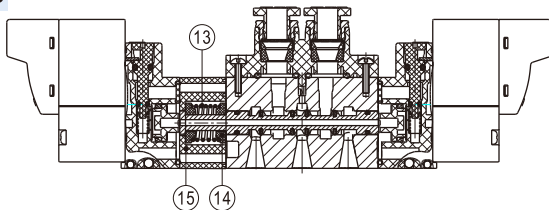

No.	Item	No.	Item	No.	Item
1	Pilot valve	6	Spool	11	Bolt
2	Manual override	7	Connecting block	12	Steel ball
3	Pilot kit	8	Little piston	13	Spring
4	Big piston	9	Gasket	14	Return holder
5	Body	10	Bottom cover	15	Side cover

Solenoid valve(5/2 way, 5/3 way)

7V Series

Dimensions

7V0510
7V110
7V210
7V310

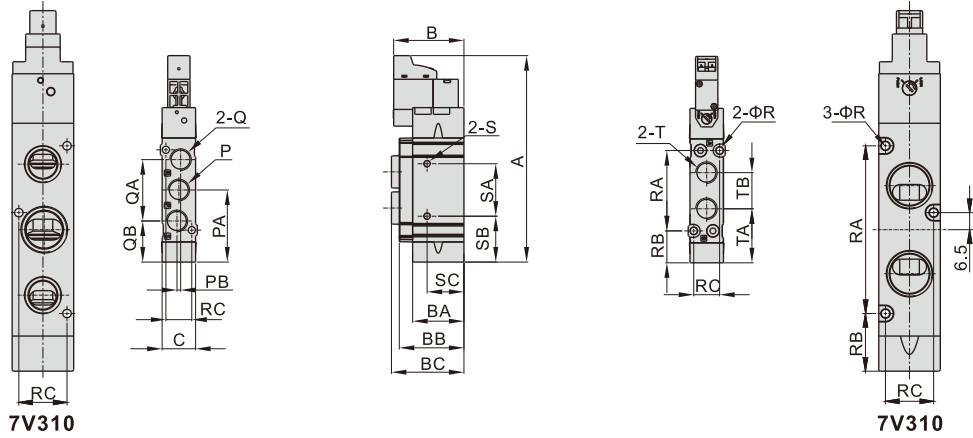

Model\Item	A	B	BA	BB	BC	C	P	PA	PB	Q	QA	QB	T	TA	TB	R	RA	RB	RC	S	SA	SB	SC		
7V0510M5	73	30.5	18.5	23	23.5	10	M5X0.8	22.5	1	M5X0.8	19	13	M5X0.8	17.5	10.5	2.1	21.4	12	8.6	M3X0.5dp3	9.5	17.8	4		
7V0510J04					32.5		Oval			Oval			Φ4(tube)							-				-	-
7V11006	92.5	32	23	29	32.5	15	1/8"	32.5	1.6	1/8"	27.2	18.5	1/8"	24	16.2	3.2	36	14.5	11.6	M3X0.5dp3	23.5	20.5	16.5		
7V110J04					38.2		Oval			Oval			Φ4(tube)							-				-	-
7V110J06					40		Oval			Oval			Φ6(tube)							-				-	-
7V110J08					41.5		Oval			Oval			Φ8(tube)							-				-	-
7V21008	106	33.5	28	34	40.5	18	1/4"	39	3	1/8"	36	21	1/4"	29	20	4.3	42	18	13.6	M4X0.7dp5	20	29	7		
7V210J08					46.5		Oval			Oval			Φ8(tube)							-				-	-
7V210J10					49		Oval			Oval			Φ10(tube)							-				-	-
7V31010					23.5		3/8"			54			0.5							1/4"				50	29

[Note]: The bottom ports of solenoid valve with tube type are oval and can only install with manifold (no side installation hole "S").

7V0520
7V120
7V220
7V320

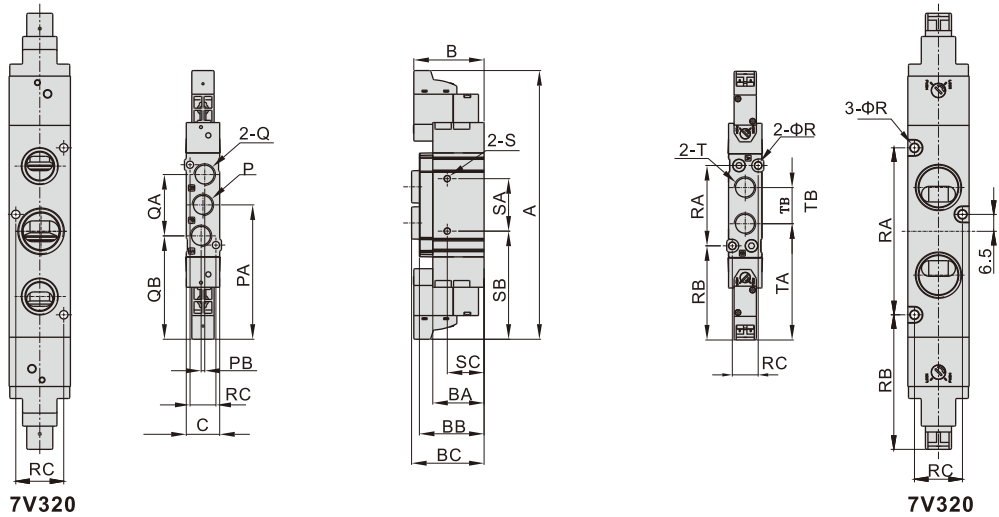

Model\Item	A	B	BA	BB	BC	C	P	PA	PB	Q	QA	QB	T	TA	TB	R	RA	RB	RC	S	SA	SB	SC		
7V0520M5	101.5	30.5	18.5	23	23.5	10	M5X0.8	50.5	1	M5X0.8	19	41	M5X0.8	45.5	10.5	2.1	21.4	12	8.6	M3X0.5dp3	9.5	17.8	4		
7V0520J04					32.5		Oval			Oval			Φ4(tube)							-				-	-
7V12006	120.5	32	23	29	32.5	15	1/8"	60.5	1.6	1/8"	27.2	46.5	1/8"	52	16.2	3.2	36	14.5	11.6	M3X0.5dp3	23.5	48.5	16.5		
7V120J04					38.2		Oval			Oval			Φ4(tube)							-				-	-
7V120J06					40		Oval			Oval			Φ6(tube)							-				-	-
7V120J08					41.5		Oval			Oval			Φ8(tube)							-				-	-
7V22008	134	33.5	28	34	40.5	18	1/4"	67	3	1/8"	36	49	1/4"	57	20	4.3	42	18	13.6	M4X0.7dp5	20	57	7		
7V220J08					46.5		Oval			Oval			Φ8(tube)							-				-	-
7V22008J10					49		Oval			Oval			Φ10(tube)							-				-	-
7V32010					23.5		3/8"			83.5			0.5							1/4"				50	58.5

[Note]: The bottom ports of solenoid valve with tube type are oval and can only install with manifold (no side installation hole "S").

Solenoid valve(5/2 way, 5/3 way)

7V Series

7V0530
7V130
7V230
7V330

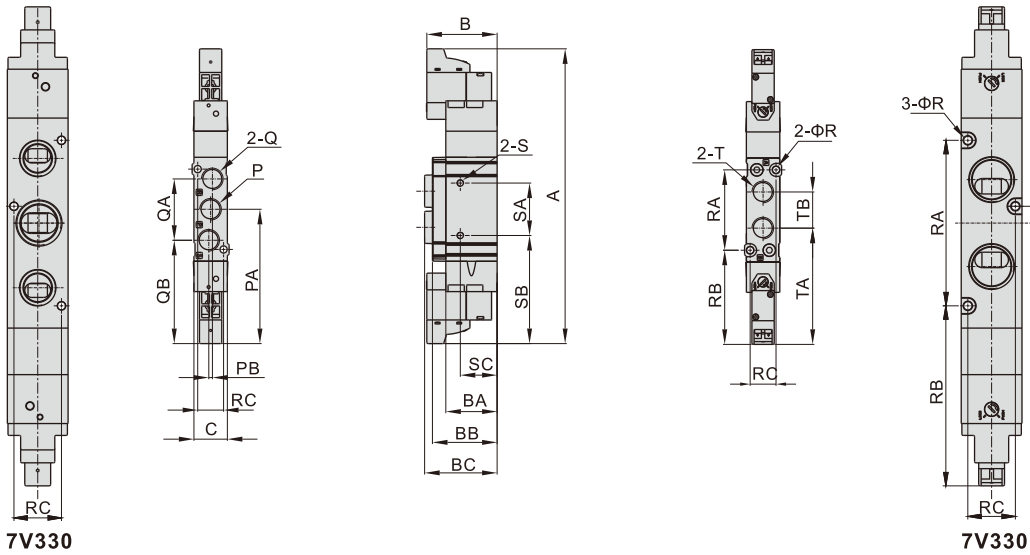

Model\Item	A	B	BA	BB	BC	C	P	PA	PB	Q	QA	QB	T	TA	TB	R	RA	RB	RC	S	SA	SB	SC
7V0530M5	110	30.5	18.5	23	23.5	10	M5X0.8	50.5	1	M5X0.8	19	41	M5X0.8	45.5	10.5	2.1	21.4	12	8.6	M3X0.5dp3	9.5	45.8	4
7V0530J04					32.5		Oval			Oval			Φ4(tube)							-	-	-	
7V13006	132	32	23	29	32.5	15	1/8"	60.5	1.6	1/8"	27.2	46.5	1/8"	52	16.2	3.2	36	14.5	11.6	M3X0.5dp3	23.5	48.5	16.5
7V130J04					38.2		Oval			Oval			Φ4(tube)							-	-	-	
7V130J06					40		Oval			Oval			Φ6(tube)							-	-	-	
7V130J08					41.5		Oval			Oval			Φ8(tube)							-	-	-	
7V23008	147	33.5	28	34	40.5	18	1/4"	67	3	1/8"	36	49	1/4"	57	20	4.3	42	18	13.6	M4X0.7dp5	20	57	7
7V230J08					46.5		Oval			Oval			Φ8(tube)							-	-	-	
7V230J10					49		Oval			Oval			Φ10(tube)							-	-	-	
7V33010	185	46	-	-	46	23.5	3/8"	101.5	0.5	1/4"	50	76.5	3/8"	85	33.5	3.2	64	69.5	18.4	Φ4.3	25	89	8

[Note]: The bottom ports of solenoid valve with tube type are oval and can only install with manifold (no side installation hole"S").

Accessories—Mounting bracket

1、Ordering code

F-7V100 LB

① ② ③

① Accessories code	F: Mounting accessories		
② Valve type	7V0500: 0500 Series	7V100: 100 Series	7V200: 200 Series
③ Accessories type	LB: LB Type(Side mounted)	LBD: LB Type(Bottom mounted)	

Note : 1、 Each mounting bracket with 4pcs mounting screws.
2、 Packed in PE bags with blank labels.

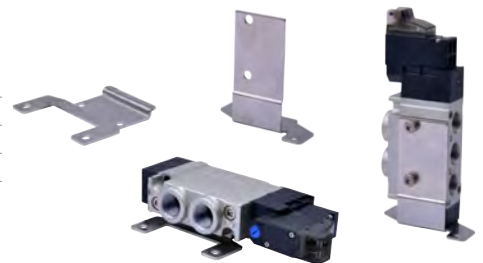

2、Dimensions

Side mounted

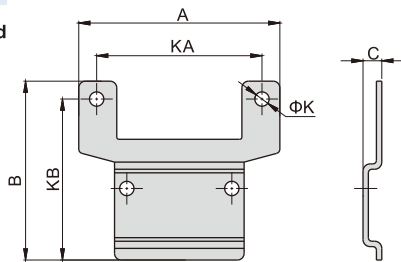

Model\Item	A	B	C	K	KA	KB
F-7V0500LB	35	35	4.2	3.2	27	31.5
F-7V100LB	45	40	4.2	3.2	37	36
F-7V200LB	66	49	4.2	4.2	52	42

Bottom mounted

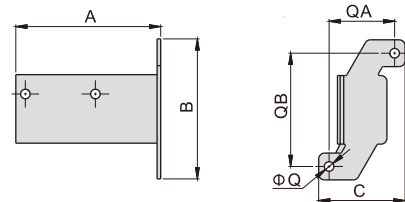

Model\Item	A	B	C	Q	QA	QB
F-7V0500LBD	32.5	38	24	3.2	17	31
F-7V100LBD	48.5	47	29	3.2	22	38
F-7V200LBD	57	57	38	4.2	28	46