

ASM 124: Damper actuator

How energy efficiency is improved

Torque-dependent cut-off facility for efficient usage of energy

Features

- For operating air dampers, shut-off dampers, butterfly valves and multi-leaf dampers
- For controllers with switching (2- and 3-point) output
- Synchronous motor with electronic activation and cut-out
- Maintenance-free gear unit
- Electronic end position detector and motor cut-off
- Self-centring spindle adapter for fitting onto damper spindle
- Gear unit can be disengaged to position the damper and for manual adjustment
- Suitable for all fitting positions
- Threaded holes (M5) for fitting to bracket
- Version with halogen-free cable on demand



ASM124F12



Technical data

Power supply

Power supply 230 V~	±15%, 50...60 Hz
Power supply 24 V~	±20%, 50...60 Hz

Parameters

Torque and holding torque	18 Nm
Running time for 90°	120 s
Angle of rotation	Max. 95°
Admissible damper shaft	Ø 12...20 mm, □ 10...16 mm
Admissible damper shaft (hardness)	max. 300 HV
Operating noise	< 30 dB (A)
Response time	200 ms

Ambient conditions

Admissible ambient temperature	-20...55 °C
Admissible ambient humidity	< 95% rh, no condensation

Construction

Weight	1.2 kg
Housing	Lower section black, upper section yellow
Housing material	Fire-retardant plastic
Power cable	1.2 m long, 3 × 0.75 mm²

Standards and directives

Type of protection	IP40 (EN 60529), IP43 (EN 60529), IP54 (EN 60529), IP55 (EN 60529)
Protection class 230 V	II (EN 60730)
Protection class 24 V	III (EN 60730)
EMC Directive 2014/30/EU	EN 61000-6-1, EN 61000-6-2 EN 61000-6-3, EN 61000-6-4
Low-Voltage Directive 2014/35/EU	EN 60730-1, EN 60730-2-14
Over-voltage categories	III
Degree of contamination	II
Mode of operation	Type 1 AB (EN 60730) Type 1 C (EN 60730)
Software	A (EN 60730)

Overview of types

Type	Voltage	Power consumption
ASM124F120	230 V~	2.9 W, 5.6 VA
ASM124F122	24 V~	2.3 W, 2.4 VA



 **Power consumption when idle:**

 *ASM124F120: 0.5 W, 5.1 VA*

 *ASM124F122: 0.03 W, 0.4 VA*

Accessories

Type	Description
0361977001	Assembly materials for M3R/M4R, MH32F/MH42F with ASM 124
0370059000	Clamping lever for shaft, Ø 8...18 mm
0370990001	Auxiliary change-over contacts, single
0370990002	Auxiliary change-over contacts, double
0370992001	Potentiometer, 2000 Ω, 1 W
0370992002	Potentiometer, 130 Ω, 1 W
0372200001	Fitting bracket
0372201001	Spindle extension with coupling
0372202001	Lever, fitting strip
0372203001	Driver axle for auxiliary contacts
0372204001	Spindle for clamping lever 0370059
0372455001	Assembly part; DEF DN25...65 for ASM 124/134
0372455002	Assembly part; DEF DN80...100 for ASM 124; DN125 for ASM 134

 *Auxiliary change-over contacts: Infinitely variable 0...90°, admissible load 5(2) A, 24...230 V*

Description of operation

The concept of synchronous motor and electronics enables the parallel operation of multiple air dampers with different torques. When voltage is applied to the cable, the control unit to be activated is moved to any desired position.

Direction of rotation for 3-point control (viewing the spindle adaptor from the actuator):

- The spindle adaptor turns in the clockwise direction, with the voltage on the brown cable (2a).
- The spindle adaptor turns in the anti-clockwise direction, with the voltage on the black cable (2b).

Direction of rotation for 2-point 24V control (viewing the spindle adaptor from the actuator):

There is always voltage on the black cable (2b):

- The spindle adaptor turns in the clockwise direction, with the voltage on the brown cable (2a).
- The spindle adaptor turns in the anti-clockwise direction, with no voltage on the brown cable (2a).

Direction of rotation for 2-point 230V control (viewing the spindle adaptor from the actuator):

There is always voltage on the brown cable (2a):

- The spindle adaptor turns in the anti-clockwise direction, with the voltage on the black cable (2b).
- The spindle adaptor turns in the clockwise direction, with no voltage on the black cable (2b).

In the end positions, the electronic end position detection (motor cut-off) is activated. In the case of an overload, a magnetic coupling secures the gear unit. The effective end position results from the limit stop of the damper or the angle-of-rotation limit or by reaching the maximum angle of rotation of 95°. The manual adjustment is performed by turning the spindle adaptor after releasing the gear unit (button on housing cover).

With 3-point control, the direction of rotation is changed by swapping the connections.

Additional technical data

The upper section of the housing with the cover, manual adjustment knob and cover knob contains the synchronous motor with capacitor and the electronics for the activation and the cut-off. The lower section of the housing contains the maintenance-free gear unit, the magnetic coupling and the spindle adaptor. To reverse the direction of rotation for 3-point control, the brown and black cables must be swapped.

Auxiliary change-over contacts

Switch rating max. 250 V~, current min. 20 mA at 20 V

Switch rating max. 4...30 V=, current min. 1...100 mA

Intended use

This product is only suitable for the purpose intended by the manufacturer, as described in the "Description of operation" section.

All related product regulations must also be adhered to. Changing or converting the product is not admissible.

Engineering and fitting notes

The actuator can be fitted in any position and can be plugged directly onto the damper spindle and fixed by means of the self-centring clamping lever.



Note
The housing must not be opened.

The maximum accessory equipment for an actuator is: 1 single auxiliary contact or 1 double auxiliary contact or 1 potentiometer. The angle of rotation can be limited to between 0° and 90° in 5° stages. The limitation is defined by means of a setting disc (under the coupling piece). This coupling piece is suitable for Ø 12...20 mm and 10...16 mm damper spindles.

Outdoor installation

We recommend protecting the devices from the weather if they are installed outside buildings.

Disposal

When disposing of the product, observe the currently applicable local laws. More information on materials can be found in the Declaration on materials and the environment for this product.

Connection diagram

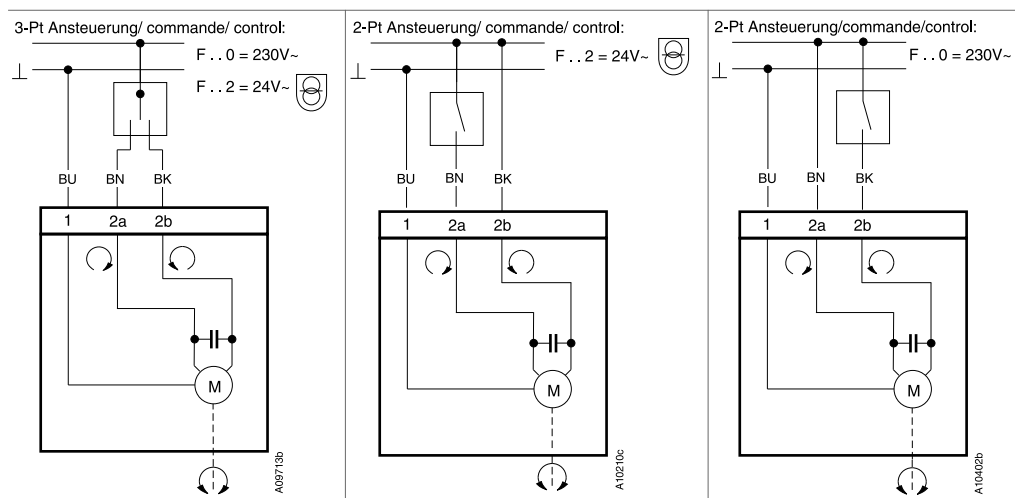

Accessories

370990/001

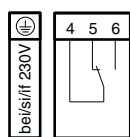

370990/002

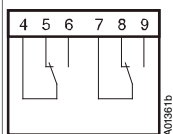

370992

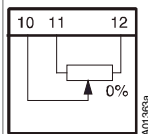

Dimension drawing

ASM 124: Ø 12...20 mm
□ 10...16 mm

ASM 134: Ø 12...20 mm
□ 10...16 mm

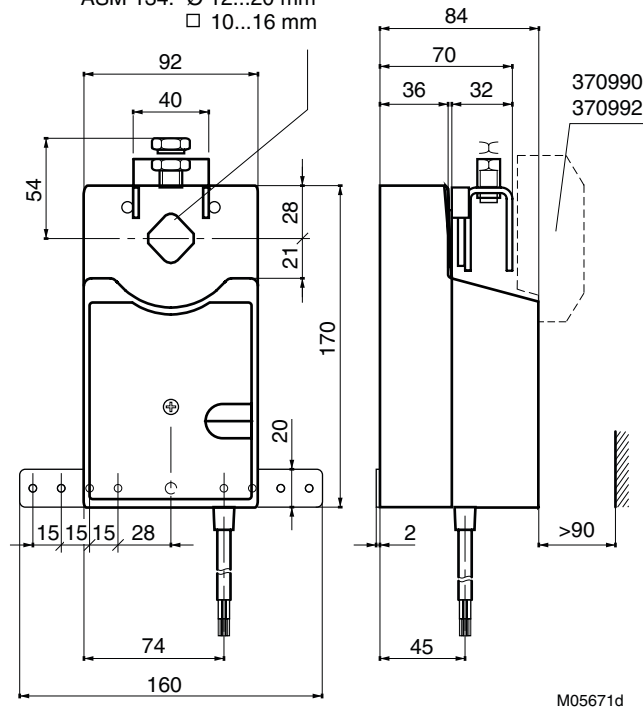

Accessories

