



# **SUPPLY NETWORK ANALYZER**

**AR5 and AR5-L**

# **INSTRUCTION MANUAL**

**( M98151101-03-10B )**

**(c) CIRCUTOR S.A.**

<b>CONTENTS</b>	<b>page</b>
1.- BASIC INSTRUCTIONS .....	4
1.1.- Introduction: check the contents of your package .....	4
1.2.- Safety conditions.....	4
1.3.- Connection instructions.....	4
1.4.- Operation instructions .....	5
2.- ANALYZER MAIN FEATURES.....	6
2.1.- Basic features .....	6
2.2.- Other characteristics .....	6
3.- KEYBOARD FUNCTIONS .....	9
4.- Installation AND START-UP .....	9
4.1.- Steps necessary for the START-UP .....	9
4.2.- Connection diagram.....	11
4.3.- Starting the analyzer up .....	16
4.4.- Loading a new program .....	18
4.5.- Turn the analyzer off.....	19
4.6.- Back-light.....	19
4.7.- Choice of the working program .....	19
4.8.- Recharging the analyzer battery .....	20
4.9.- Energy saving .....	20
5.- DATA VISUALIZATION ON DISPLAY .....	21
5.1.- Base screen.....	21
5.1.1.- Screen of instantaneous values .....	21
5.1.2.- Screen of maximum and minimum values .....	22
5.2.- Other visualization screens.....	23
5.2.1.- Visualization of 3 parameters in a big size mode .....	23
5.2.2.- Bar graphs .....	24
5.2.3.- Oscilloscope.....	25
5.2.3.1.- Three phases: Voltage - Current.....	25
5.2.3.2.- Zoom.....	26
5.2.3.3.- Harmonic factorization. ....	27
5.2.4.- Setup visualization .....	29
5.3.- Warning messages .....	29
6.- PROGRAMMING THE ANALYZER.....	30

6.1.- SETUP menu .....	31
6.1.1.- MEASURE .....	32
6.1.1.1.- WIRING: Circuit type.....	32
6.1.1.2.- PT/CT : Transformation ratios.....	32
6.1.2.- RECORD menu .....	32
6.1.2.1.- PERIOD: recording period .....	33
6.1.2.2.- TRIGGER: Trigger conditions .....	34
6.1.2.3.- NAME: recording file name .....	37
6.1.2.4.- PARAM: Choosing the parameters to be saved.....	38
6.1.3.- COMM: Communication parameters.....	39
6.1.4.- CLOCK: Internal clock .....	39
6.1.5.- PASSWORD: Safety setting. ....	40
6.1.6.- RECALL: Read configuration.....	41
6.2.- DISPLAY menu.....	42
6.2.1.- BAR.GR.....	42
6.2.2.- EXPAND .....	42
6.2.3.- CONTRAST: Screen contrast.....	42
6.2.4.- ANGLE.....	43
6.3.- RUN: data recording process status .....	43
6.4.- FILES Menu .....	43
6.4.1.- DIR: Directory .....	43
6.4.2.- DELETE: Deleting a file .....	43
6.4.3.- FORMAT: Formatting the analyzer internal memory.....	44
6.5.- CLEAR menu: Deleting data .....	44
6.6.- Menu OFF: Enable / Disable Password.....	45
6.7.- Menu LANGUAGE .....	45
7.- ANALYZER COMMUNICATIONS .....	45
8.- TECHNICAL SPECIFICATIONS.....	46
9.- SAFETY WARNINGS .....	48
10.- MAINTENANCE.....	49
11.- CHANGING THE BATTERY.....	49
12.- TECHNICAL SERVICE.....	50

## 1.- BASIC INSTRUCTIONS

This manual is aimed to familiarize the user with the operation of the portable power analyzers model AR5-L and AR5 in order to get the best from its features.

These analyzers have been built with components incorporating the most advanced technology in microelectronics and offer benchtop features over the market in measurement and recording of electrical magnitudes in industrial power supply networks.

You are kindly requested to **carefully read this manual before connecting and powering the analyzer** in order to avoid irreversible damage, which might be caused by an improper connection.

### 1.1.- Introduction: check the contents of your package

After receiving the analyzer, please check the following points:

- a) The analyzer model corresponds with your order specifications.
- b) After unpacking, check that the instrument has not been damaged in transit.
- c) The standard set includes the following items:
  - Kit AR5-L or AR5
  - 1 Power supplier set 100 V a.c. – 240 V a.c. / 12 V d.c.
  - 1 Connection cord between the power supplier set and the main.
  - 1 Connection cable between the analyzer and the power supplier set.
  - 1 RS-232 communication cable.
  - 4 Voltage leads.
  - 4 Alligator clamps (3 in AR5 model).
  - 1 Instruction Manual.
  - CD with the PC program

### 1.2.- Safety conditions



The manual you hold in your hands contains information and warnings about the **analyzer** that the user should respect in order to guarantee a proper operation of all the instrument functions and keep its safety conditions.

### 1.3.- Connection instructions

Before powering and connecting the analyzer check the following points:

- a) Supply voltage: Through and external power supplier set.

Input mains 100 V a.c. – 240 V a.c. / output to AR5/AR5-L 12V d.c.
- b) Frequency : 45...65 Hz.
- c) Maximum voltage at the voltage measuring circuit:
  - 500 V a.c. Phase-to-neutral (CAT III)

d) Current measuring range: according to the Current clamp used

Current clamps	Measuring range
CP-2000-200	10 to 2000 A a.c. (switch at 2000) 1 to 200 A a.c. (switch at 200)
CPR-1000	5 to 1000 A a.c.
CPR-500	2,5 to 500 A a.c.
CP-100 (M1-U)	0, 5 to 100 A a.c.
CP-5	25 mA to 5 A a.c.

Flexible clamp	Measuring range
C-FLEX 200-2000-20000	100 to 20000 A a.c (scale 20000 A) 10 to 2000 A a.c. (scale 2000 A) 1 to 200 A a.c. (scale 200 A)

**NOTE:** It is advisable to measure near of full-scale value to get better accuracy.

#### 1.4.- Operation instructions

The **analyzer** is a programmable instrument so offering diverse operation modes, which can be selected from the available programming menus (6.- PROGRAMMING THE ANALYZER).

Please read carefully the paragraphs involving (4.- Installation AND START-UP 6.- PROGRAMMING THE ANALYZER) in order to select the most suitable operation mode for your requirements.



**If the instrument is not used according to manufacturer's specifications, the protection of the instrument can be damaged.**

## 2.- ANALYZER MAIN FEATURES

### 2.1.- Basic features

The AR5 series analyzers are programmable instruments that **measure, calculate and store to memory** the main parameters of three phase electrical supply networks.

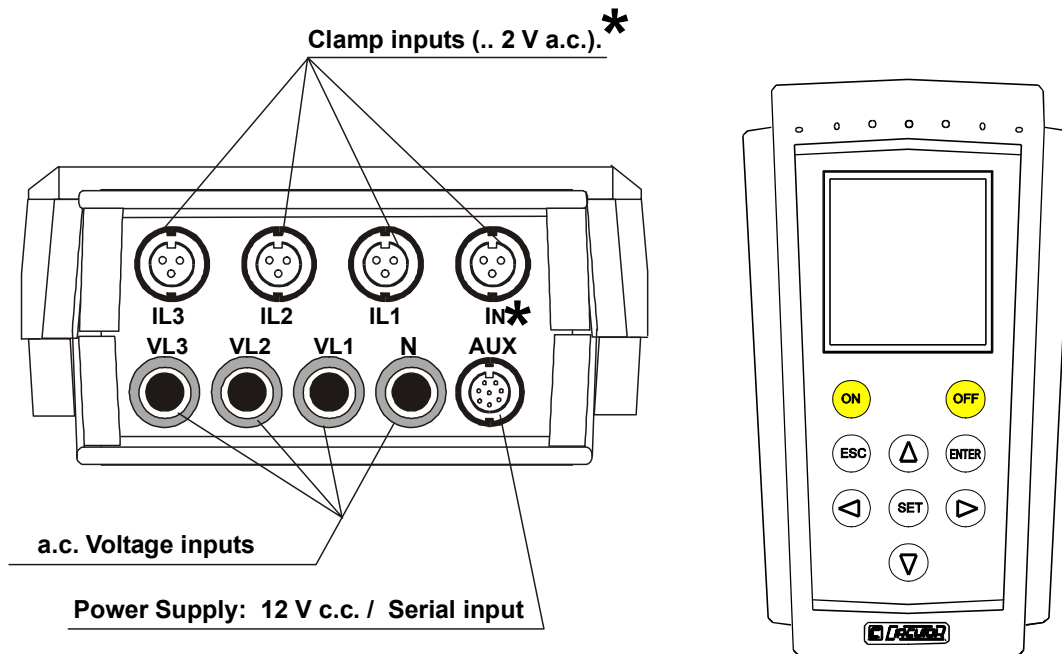

\*  $I_N$  only in AR5-L models

**Setup:** Analyzer's setting is completed through a system of spreadable menus that provide a friendly-use and intuitive configuration process.

**Data visualization:** By means of a liquid crystal graphical display, 160 x 160 pixels and with **backlight** ability, the user can view **instantaneous, maximum and minimum values of each parameter at each phase.**

**Internal battery:** permits the user to accomplish with analysis works without the need of an external auxiliary power supply. The analyzer is equipped with an intelligent battery charging system, which expands the battery life span. For recharge the battery is necessary to connect the power supplier.

**Installation:** Analyzer is suitable for analysis works over any type of electric networks (single-phase, bi-phase, 3-wire and 4-wire).

**Measuring:** Measurement of average values of main electrical parameters, as well as, recording of maximum and minimum values. To execute these measurements, the analyzer is equipped with three a.c. voltage inputs and four a.c. current inputs (through current clamps .. / 2 V a.c.).

**Data collection:** The analyzer has a **1 Mb on-board memory** to save into all the parameters measured or calculated by the analyzer, in order to be further retrieved from a PC.

**PC software:** together with the analyzer, it is also factory supplied a friendly-use, powerful software that permits data downloading from the internal memory to a PC and a further complex analysis of recorded data.

### 2.2.- Other characteristics

- Small size, low weight, portable instrument.
- True R.M.S. measuring system.
- Instantaneous, maximum and minimum values of each discrete electric parameter.
- Electrical energy meters incorporated
- Harmonic measurement
- Neutral current measurement (only in AR5-L model)
- RS-232 communication to PC
- Ability of setting a **recording threshold**, so that data is only recorded in memory when measured values are not within the defined threshold (see Section 6.1.2.2.-TRIGGER: Trigger conditions).
- Automatic data collection in memory at regular user-definable periods.

Depending on the type of circuit under analysis, following enumerated parameters are measured and can be saved in memory:

**NOTE:** It's not allow to save  $\cos\varphi$  data in memory. Only can be read on display.

• **4-wire three-phase system:**

Parameter	Symbol	L1	L2	L3	Three-phase value
Phase-to-Neutral voltage	$V$	x	x	x	
Current	$A$	x	x	x	x
Neutral current (only in AR5-L model)	$I_N$				x
Frequency	$Hz$	x			
Active power	$kW$	x	x	x	x
Reactive power L	$kvarL$	x	x	x	x
Reactive power C	$kvarC$	x	x	x	x
Apparent power	$kVA$				x
Power factor	$PF$	x	x	x	x
Active energy	$kWh$	x	x	x	x
Reactive-energy (inductive)	$kvaLh$	x	x	x	x
Reactive-energy (capacitive)	$kvaCh$	x	x	x	x
Voltage harmonics		x	x	x	
Current harmonics		x	x	x	
Current Neutral harmonics (only in AR5-L model)					x

- **3-wire three-phase system:**

Parameter	Symbol	L1-L2	L2-L3	L3-L1	Three-phase value
Phase-to-Phase voltage	<i>V</i>	x	x	x	
Current	<i>A</i>	x	x	x	x
Frequency	<i>Hz</i>	x			
Active power	<i>kW</i>	x	x	x	x
Reactive power L	<i>kvarL</i>	x	x	x	x
Reactive power C	<i>kvarC</i>	x	x	x	x
Apparent power					x
Power factor	<i>PF</i>	x	x	x	x
Active energy	<i>kW h</i>	x	x	x	x
Reactive-energy (inductive)	<i>kvahL</i>	x	x	x	x
Reactive-energy (capacitive)	<i>kvahC</i>	x	x	x	x
Voltage harmonics		x	x	x	
Current harmonics		x	x	x	

- **Single-phase system:**

Parameter	Symbol	L1
Voltage	<i>V</i>	x
Current	<i>A</i>	x
Frequency	<i>Hz</i>	x
Active power	<i>kW</i>	x
Reactive power L	<i>kvarL</i>	x
Reactive power C	<i>kvarL /(-C)</i>	x
Apparent power		x
Power factor	<i>PF</i>	x
Active energy	<i>kW h</i>	x
Reactive-energy (inductive)	<i>kvahL</i>	x
Reactive-energy (capacitive)	<i>kvahC</i>	x
Voltage harmonics		x
Current harmonics		x

- **Bi-phase system:**

Parameter	Symbol	L1-N	L2-N	Bi-phase value L1-L2
Voltage	<i>V</i>	x	x	x
Current	<i>A</i>	x	x	x
Neutral current*	<i>I<sub>N</sub></i>			x
Frequency	<i>Hz</i>	x		
Active power	<i>kW</i>	x	x	x
Reactive power L	<i>kvarL</i>	x	x	x
Reactive power C	<i>kvarC</i>	x	x	x
Apparent power				x
Power factor	<i>PF</i>	x	x	x
Active energy	<i>kW h</i>			x
Reactive-energy (inductive)	<i>kvahL</i>	x	x	x
Reactive-energy (capacitive)	<i>kvahC</i>	x	x	x
Voltage harmonics		x	x	
Current harmonics		x	x	
Neutral current harmonics				x

\*only in AR5-L model



### 3.- KEYBOARD FUNCTIONS

The analyzer has a 9 buttons keyboard to perform configuration and control actions of all the instrument options.

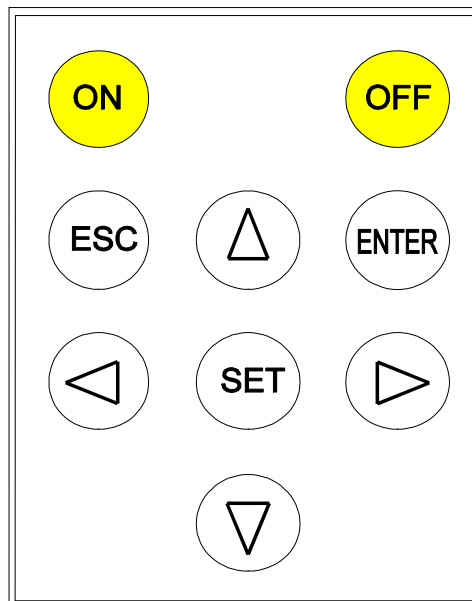

- [ON] to turn the analyzer on.
- [OFF] (Quick press) to turn on/off the display back-light.
- [OFF] (5 seconds press) to turn analyzer off.
- [▼], [▲], [▶] & [◀]. To select among several options.
- [SET] to access setting options.
- [ENTER] to validate a setting option or to program some parameters of the visualization screens.
- [ESC] to select different visualization screens or to exit the setting actions.

However, **most of keys are double functional**: The own instrument understands the meaning of the order at each case.

### 4.- Installation AND START-UP



The manual you hold in your hands contains information and warnings that the user should respect in order to guarantee a proper operation of all the instrument functions and keep its safety conditions.

**If the instrument is not used according to manufacturer's specifications, the protection of the instrument can be damaged.** Note that with the instrument powered on, cover opening or elements removal actions may allow accessing dangerous parts. Therefore, before any adjustment, replacement, maintenance or repairing operation is carried out, the instrument must be disconnected from any power supply source.

When any protection failure is suspected to exist, the instrument must be immediately put out of service. Contact then with a qualified service representative.

#### 4.1.- Steps necessary for the START-UP

For the Star-up of the equipment and to let it ready to begin to register is necessary to make the following steps.

- 1) Plug the battery, see point 11.-CHANGING THE BATTERY
- 2) Format the memory, see 6.4.3.-FORMAT: Formatting the analyzer internal memory
- 3) Set the analyzer in hour, see point 6.1.4.-CLOCK: Internal clock
- 4) Charge the battery by a period of minimum 14 hours. .

**4.2.- Connection diagram**

**A.- CONNECTION DIAGRAM FOR THREE-PHASE - 4-WIRE – SYSTEM**

This connection is only available for AR5-L model

( SET ---> SETUP ---> MEASURE ---> WIRING ---> 3Φ 4 WIRES)

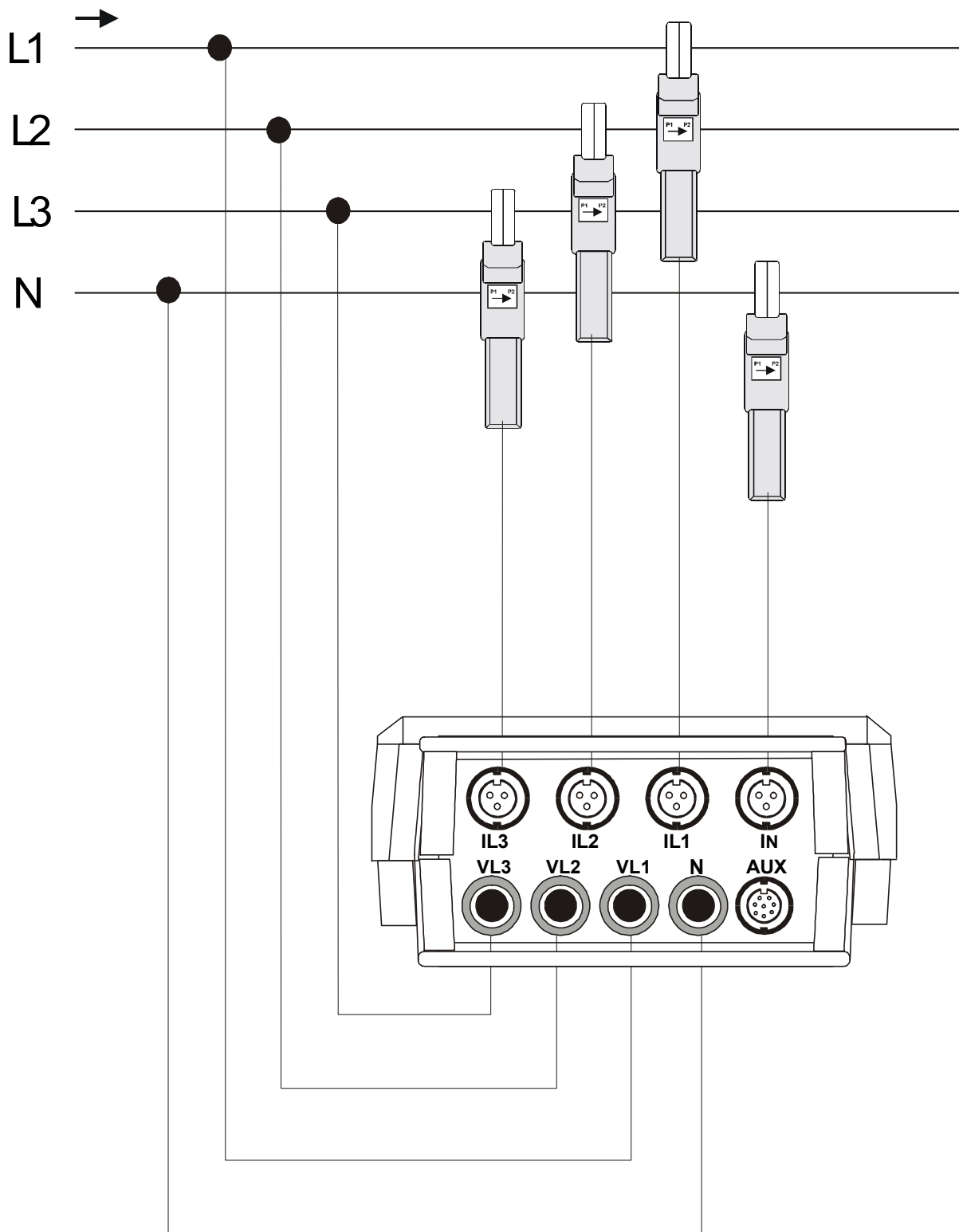

**B.- CONNECTION DIAGRAM FOR THREE-PHASE - 3-WIRE - SYSTEM.**

( SET ---> SETUP ---> MEASURE ---> WIRING ---> 3Φ 3 WIRES )

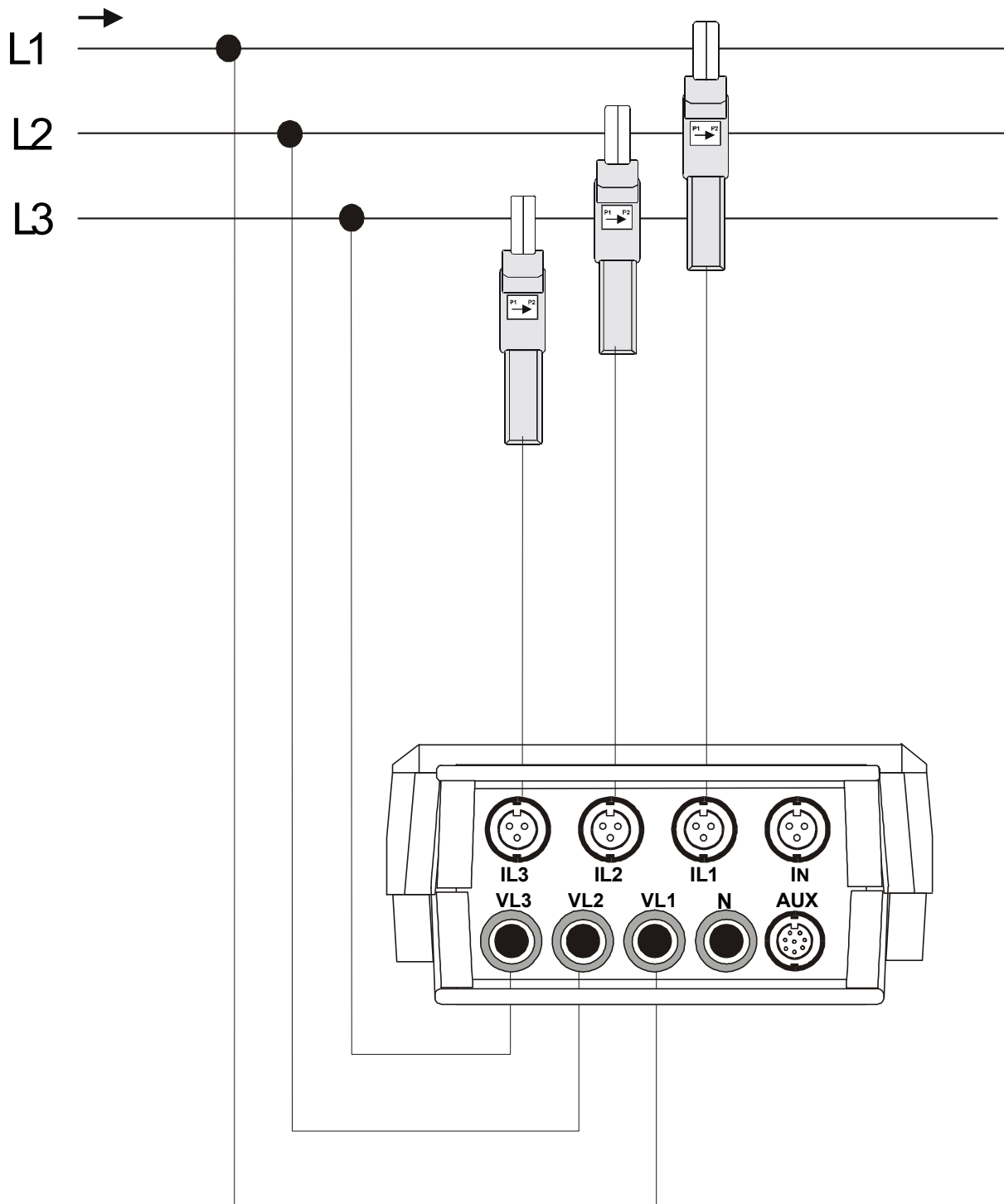

**C.- CONNECTION DIAGRAM FOR THREE-PHASE - 3-WIRE (ARON)**

( SET ---> SETUP ---> MEASURE ---> WIRING ---> 3 PT – 2 CT

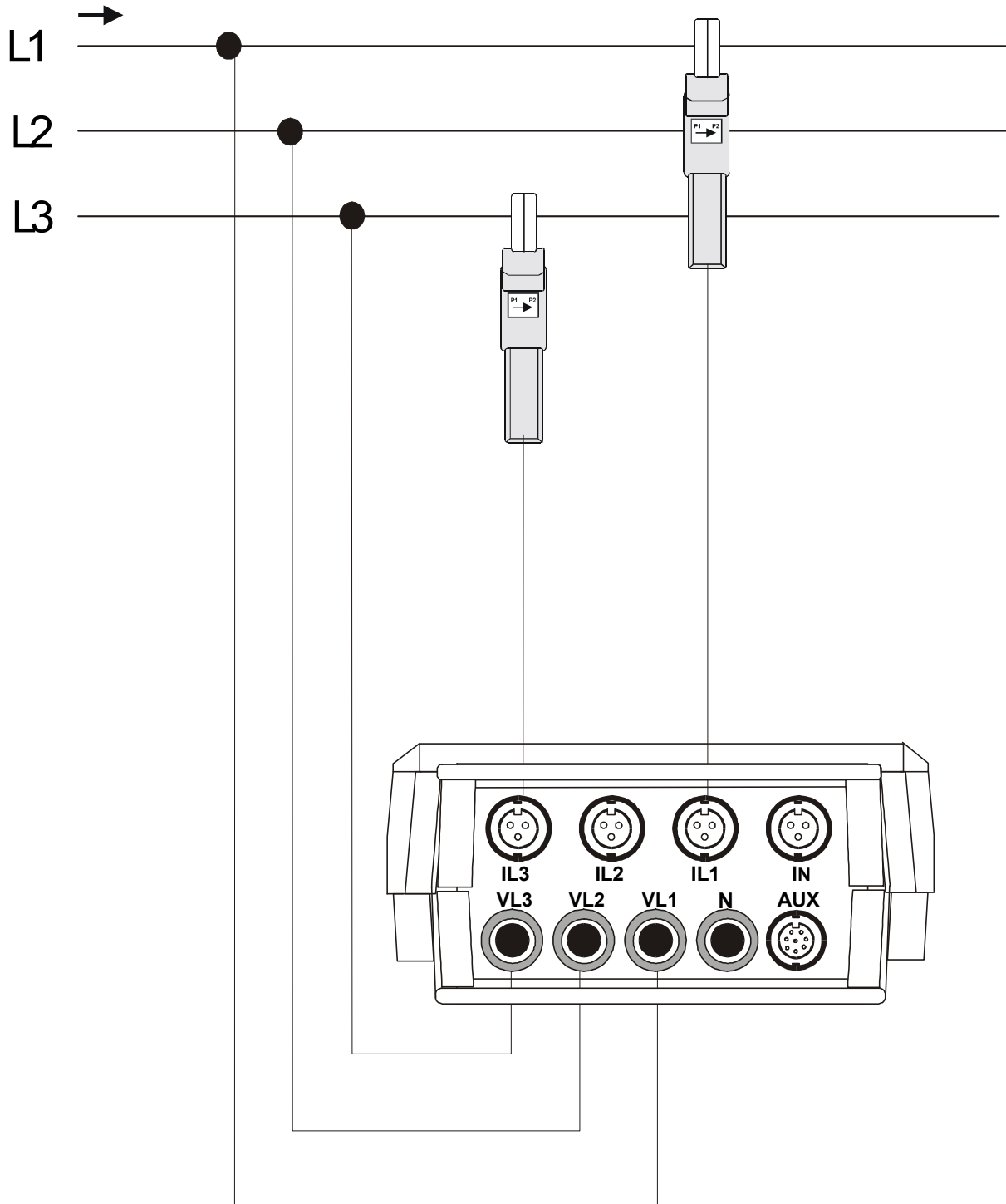

**D.- CONNECTION DIAGRAM FOR SINGLE-PHASE - SYSTEM**

( SET ---> SETUP ---> MEASURE ---> WIRING ---> 1Φ )

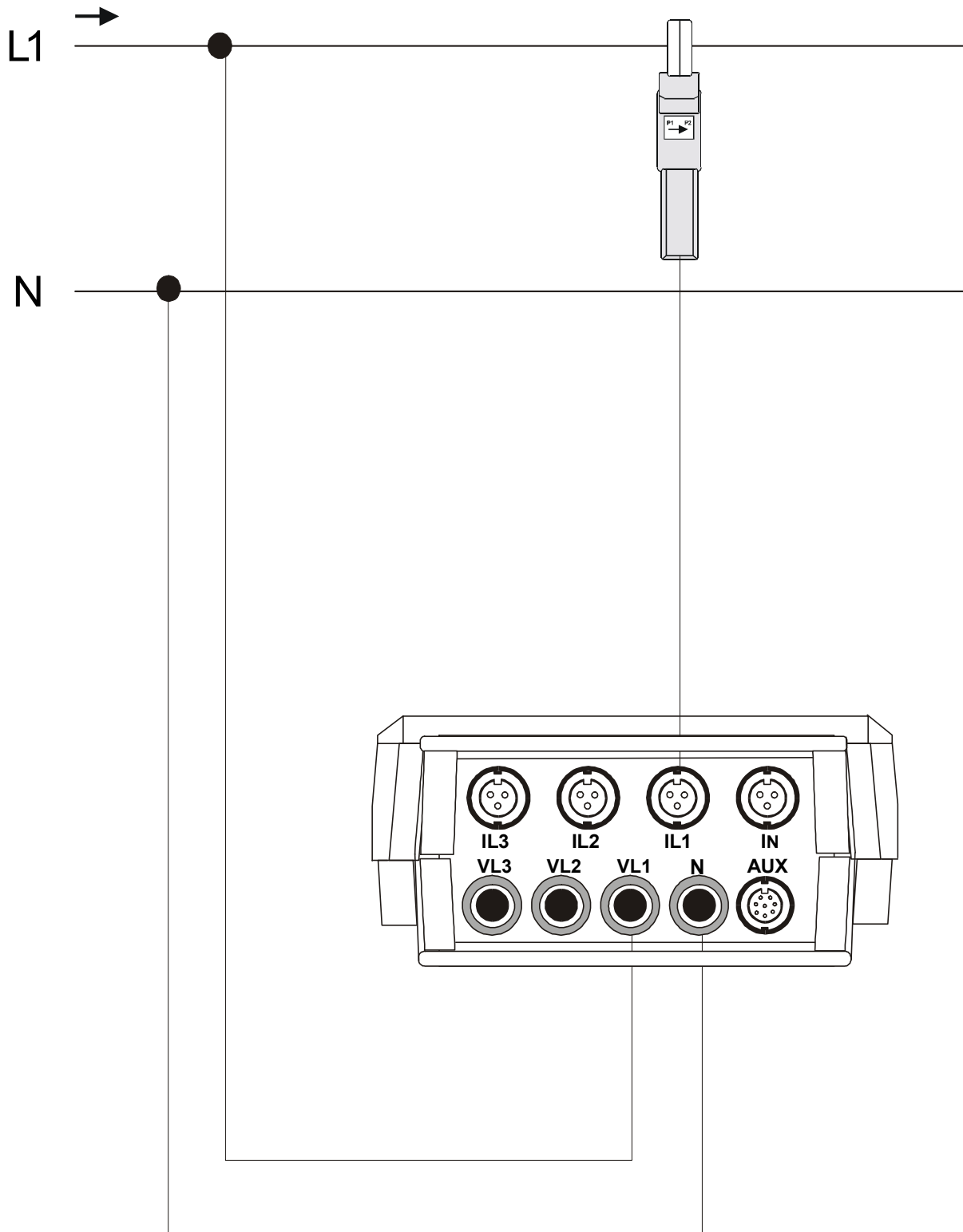

**E.- CONNECTION DIAGRAM FOR BI-PHASE - SYSTEM**

This connection is only available for AR5-L model

( SET ---> SETUP ---> MEASURE ---> WIRING ---> 1 $\Phi$  Split )

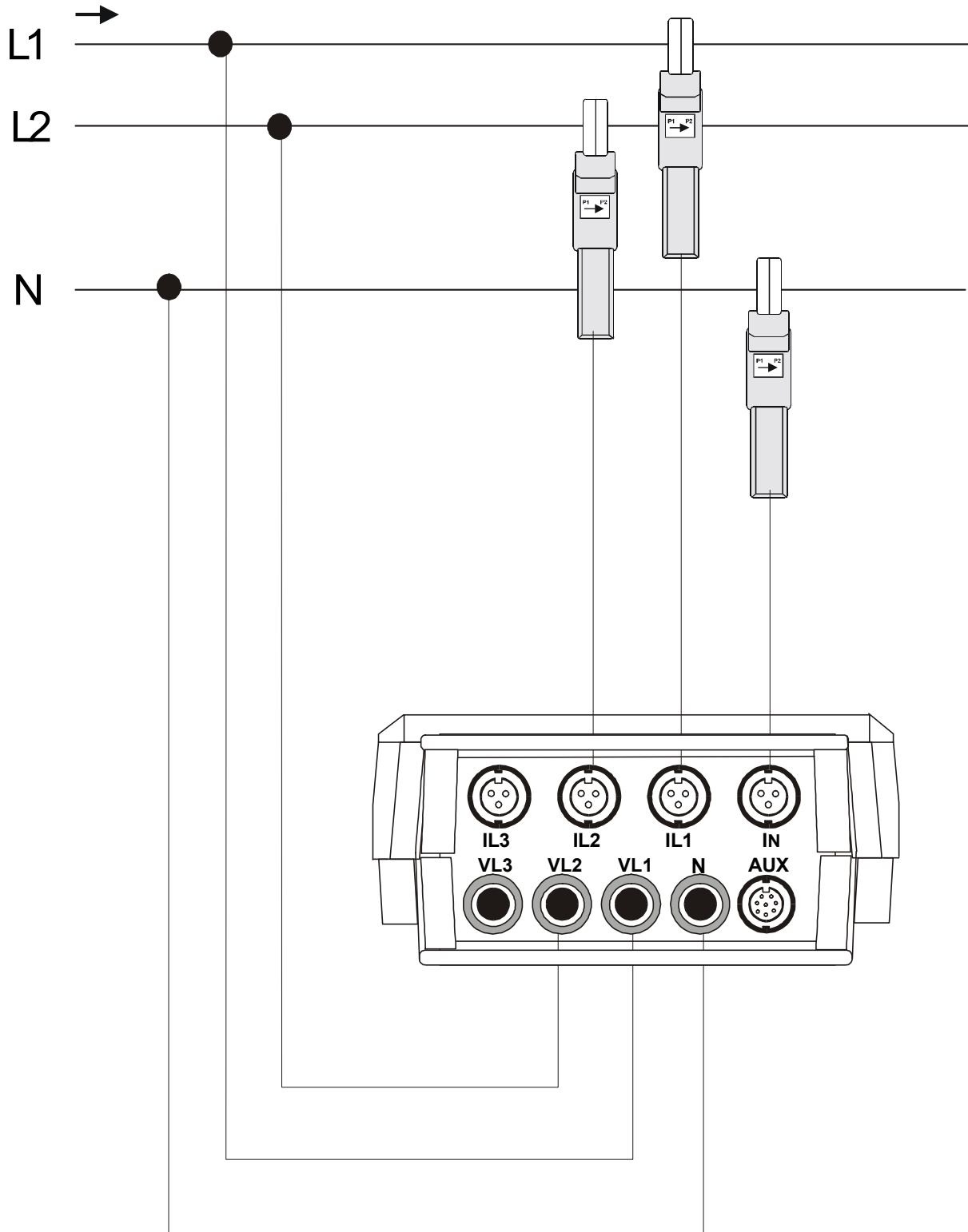

### 4.3.- Starting the analyzer up

Before connecting the instrument to the mains, please consider following points:

- 5) Supply voltage: 100 V a.c. – 240 V a.c. , 50... 60 Hz.

The instrument must be energized by a supply circuit with protection earth terminal.

- 6) Maximum input voltage at the voltage measuring circuit:  
 500 V a.c. phase-neutral (CAT III)

Use always the voltage leads factory-shipped with the instrument.

- 7) Burden: 15 VA.
- 8) Operation conditions:  
 - Operation temperature: 0 °C to 40 °C.  
 - Operation humidity: 80% for temperatures up to 31°C decreasing linearly to 50% relative humidity at 40°C.
- 9) Safety : Designed to meet protection category III 600V as per EN 61010.
- 10) Current measuring range: according to the current clamp used

Current clamps	Measuring range
CP-2000-200 clamp	10 to 2000 A a.c. (scale 2000 A) 1 to 200 A a.c. (scale 200 A)
CPR-1000 clamp	5 to 1000 A a.c.
CPR-500 clamp	2,5 to 500 A a.c.
CP-100 (M1-U) clamp	0,5 to 100 A a.c.
CP-5 clamp	25 mA to 5 A a.c.

Flexible clamp	Measuring range
C-FLEX 200-2000-20000	100 to 20000 A a.c. (scale 20000 A) 10 to 2000 A a.c. (scale 2000 A) 1 to 200 A a.c. (scale 200 A)

**NOTE:** It is always advisable to take measurements at the high range of the scale to obtain a better accuracy.

#### To start measurement works with the analyzer:

- 11) Connect to the main with the factory-shipped cables. Also connect the protection earth terminal to avoid possible disturbances over the analyzer.
- 12) Connect the voltage leads at each phase of the monitored system, as well as the neutral when it exists.
- 13) Connect the Current clamps at each phase conductor. Each current phase must coincide with its voltage phase.
- 14) Respect the connection modes shown at each diagram to correctly achieve powers, PF and energies readouts.



**To turn the instrument on:**

- 15) Press the switch <ON> at the analyzer frontal cover. The analyzer introduction screen appears. The user can now select the operation mode program for the analyzer
- 16) After some seconds, a screen allowing the choice of the analyzer program to be used is shown up.
- 17) Once the desired program has been selected, analyzer will check the type of ammeter clamps connected to the analyzer. This process is only performed when analyzer is turn on, and in case that the connected clamps does not matches with the programmed ones, then the analyzer will automatically give the option to change the ammeter clamp setting:
  - Press <ENTER> to validate the suggested clamp setting. The new transformation ratio will be set at the ratio detected in the clamp L1.
  - Press <ESC> to exit the auto-checking process with no change in the analyzer setup.
- 18) After some seconds the principal electrical parameters of the network are displayed.

**NOTE :** *If nothing is shown on display, a discharged battery or any problem with the display contrast might exist.*

**Initial considerations after the analyzer start-up:**

- Format the memory if necessary (see section 6.4.-FILES Menu).
- Clear maximum & minimum values as well as energy counters if necessary (see section 6.5.- CLEAR menu: Deleting data).
- Open a file with the desired name (see section 6.1.2.3.- NAME: recording file name). All data will be automatically saved in this file until a new one is opened. The analyzer internal memory can contain several files (different analysis).

**Warning :**

Take into account that when the memory is formatted all previously stored data is lost. When opening a new file (a different name that the previous one) the internal memory is not deleted.

**When starting new measurements** at any installation **the meter programming** must be checked and modified if necessary (following steps attached at Section 6.- PROGRAMMING THE ANALYZER) Otherwise, the analyzer will work according the last used program (this is saved in memory even after powering the meter off).

**Points to be mainly checked would be:**

- Ratio of Current clamps (see section 6.1.1.2.-)
- Voltage transformer ratio (see section 6.1.1.2.-)
- Recording period (see section 6.1.2.1.-)

#### 4.4.- Loading a new program

The analyzer has an internal memory to save diverse operation mode programs to be used by the user.

Before starting this action, check that analyzer is supplied through the power supplier set.

To load any program, follow these instructions precisely:

- Turn the meter off.
- It is necessary to load a coprocessor that comes in a cartridge to part, and that must settle only in the position of the coprocessor (the last position of the list)
- Connect the cartridge into the appropriate input placed in the power supplier set.
- Turn the meter on.
- Select with the keys [**▲**] & [**▼**] that you want to perform a program loading action (LOAD PROGRAM). Press [**ENTER**] or wait for a while to confirm this operation.
- Select the position to save the program into.
- The analyzer will perform a test to check that the cartridge has been properly connected.
- If an inserted cartridge is detected, then the program will be loaded.
- Once the loading is completed, reset the meter.
- If no cartridge was found or a loading mistake occurred, reset the meter and redo the above steps.

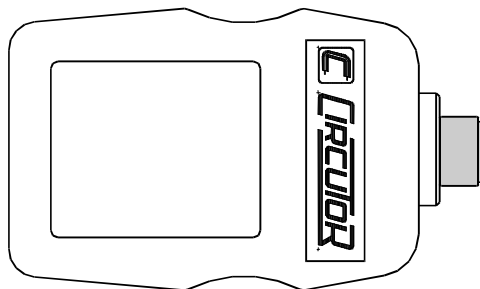

**A cartridge will be only valid for the analyzer, which the program was for the first time loaded into.**

**Note on the cartridge the serial number of its related analyzer.**

#### 4.5.- Turn the analyzer off

To turn the analyzer off proceed as follows:

- If no password is set (**Default option**):
  - Press the key **[OFF] during 5 s**
- If a password is set:
  - Press the key **[OFF] during 5 s**
  - You will see in display:

<b>PASSWORD</b>

- Enter the set password or, if this has not been previously modified, the default password **[▲] [SET] [▲] [SET]**.
- Press again the key **[OFF]**. (In case of a correct password, the analyzer will turn off).

#### 4.6.- Back-light

To turn the display backlight on/off just make a **quick press** on the key **[OFF]**.

#### 4.7.- Choice of the working program

The analyzer can hold in memory different operation mode programs. The choice of the program to be used is done when starting the meter up.

- Turn the analyzer on.
- A list of available programs will be shown on display.
- Use keys **[▲]** & **[▼]** for the choice of the desired program.
- Press **[ENTER]** or wait for a while to confirm this operation.

<b>CHECK THE SETUP !!!!</b>
-----------------------------

All the programs have an independent disposition, therefore, the disposition will be due to always verify, to assure an appropriate operation.

For instance, if the setup is modified at the "ANALYZER" program, these modification will not be valid for the "HARMONIC" program, and so for any program.

#### 4.8.- Recharging the analyzer battery

The analyzer is equipped with an intelligent energy charging system. This means that the instrument continuously checks in an automatic way the state of the battery, thus the charging process stops when the battery is at its maximum charge level. The span life of the battery is so increased.

To enable the battery charging proceed as follows:

- Connect the power supplier set to the main.
- Connect the analyzer to the power supplier set.
- Turn the analyzer on by pressing button **[ON]**.

Provided the analyzer is connected to the main through the power supplier set, the battery is self-recharging.

If the battery is exhausted, the charging process should last at least 3 hours with no interruption; although a charging period of 16 hours is advisable in order to completely charge the battery.

The analyzer shows on screen a battery charge indicator: 

**NOTE:** The battery charge is only used while the ANALYZER is turn on.

#### 4.9.- Energy saving

The ANALYZER has an energy saving system. So, if no key is pressed for at least 5 minutes, the display is automatically off. The analyzer continues the recording data process but nothing appears on display.

The display will automatically be active when any key is pressed (excepts for the key **[ON]** that causes no effect).

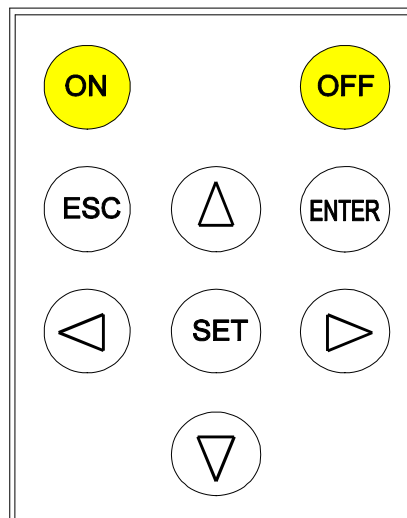

## 5.- DATA VISUALIZATION ON DISPLAY

All measured instantaneous values, as well as maximum and minimum, can be read on a 160 x 160 pixel, liquid, crystal display (back-light ability).

An indication of the type of data being displayed is shown at the upper right corner.

### 5.1.- Base screen

#### 5.1.1.- Screen of instantaneous values

When powering the analyzer on, the display will show:

HARMONICS				
INST	L1	L2	L3	III
Vp-n	220	221	223	221
A				
kW				
kvarL				
kvarC				
P.F.				
Hz				
kVA				
A <sub>N</sub>				
kWh			0.000	
kvarLh			0.000	
kvarCh			0.000	
25 / 10 / 04 17 : 31 : 29				

Instantaneous value screen

**Voltage:** Readout of the instantaneous RMS value measured at each phase (L1, L2 & L3) and the average value of the instantaneous values of the three phases (III).

**Current :** Readout of the instantaneous RMS value measured at each phase (L1, L2 & L3) and the average value of the instantaneous values of the three phases (III).

**Active power:** The active power is calculated from instantaneous voltage and current data. The readout gives the instantaneous values of the active power of each phase and also the three phase total instantaneous active power, which is the addition of each phase value.

**Inductive reactive power:** The inductive reactive power is calculated from instantaneous voltage and current data. The readout gives the instantaneous values of the inductive reactive power of each phase and also the three phase total instantaneous inductive reactive power, which is the addition of each phase value.

**Capacitive reactive power:** The capacitive reactive power is calculated from instantaneous voltage and current data. The readout gives the instantaneous values

of the capacitive reactive power of each phase and also the three phase total instantaneous capacitive reactive power, which is the addition of each phase value.

Power factor : Readout of the power factor of each phase and the three phase average value.

Frequency : Readout of the instantaneous value of the frequency (Hz).

Neutral Current : Readout the value measured of the neutral current. (only in AR5-L model)

Apparent power : Readout of the three phase total instantaneous apparent, which is the addition of each phase value.

Energies: Readout of active, inductive reactive, and capacitive energy counters from the moment that the energy counters were reset to zero (see section 6.5.-)

Time and Date. (time/date): Readout of present time and date. For any modification, see section 6.1.4.- *CLOCK: Internal clock.*

### 5.1.2.- Screen of maximum and minimum values

HARMONICS				
MAX	L1	L2	L3	III
Vp-n	220	221	223	221
A				
kW				
kvarL				
kvarC				
P.F.				
Hz				
kVA				
A <sub>N</sub>				
kWh		-0.000		
kvarLh		-0.000		
kvarhC		-0.000		
25 / 10 / 03 17 : 31 : 29				

Screen of maximum values

An indication of the type of data being displayed is shown at the upper right corner: INST (Instantaneous), MAX (Maximum) or MIN (Minimum).

Maximum and minimum values displayed correspond to the maximum and minimum values obtained from the instantaneous values.

The negative energy counters are then displayed in place of positive energies.

## 5.2.- Other visualization screens

Through the key **[ESC]** other additional screens can be displayed.

This screen might lightly vary according to the user-selected measuring circuit type (Wiring).

### 5.2.1.- Visualization of 3 parameters in a big size mode

Three instantaneous parameters of your choice can be bigger size displayed for a clearer reading.

INST	HARMONICS
Vp-n L1	<b>220</b>
Vp-n L2	<b>221</b>
Vp-n L3	<b>224</b>
09 / 01 / 04 17 : 31 : 29	

**NOTE :** The 3 parameters to be displayed can be selected as follows:

a.- Pressing: **SET --> DISPLAY ---> EXPAND.**

b.- Directly pressing **[ENTER]**:

**To modify:**

- Select with the keys **[▼]**, **[▲]**, **[▶]** or **[◀]** the desired parameter and press **[SET]** to validate the choice.
- Select "CLEAR ALL " on display + **[SET]** to clear all parameters.
- **[ENTER]** to validate the choice or **[ESC]** to exit with no modification.

Only three parameters can be selected at once.

### 5.2.2.- Bar graphs

Simultaneous graphic representation on display of the three phases (L1, L2 & L3) of the selected parameter.

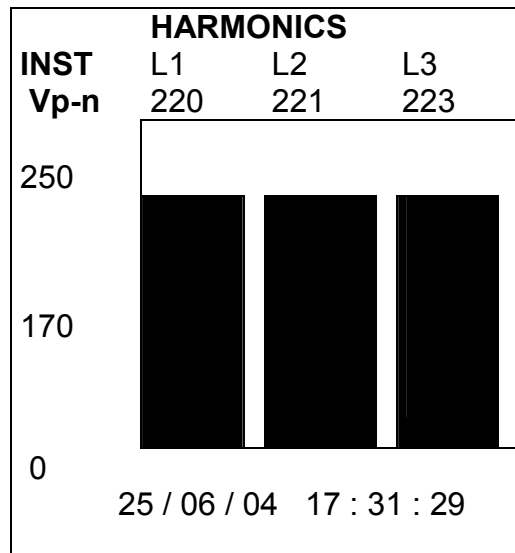

**NOTE :** Both the parameter to be displayed and the graphic scale can be selected as follows:

a.- Press: **SET --> DISPLAY ---> BAR.GR.V**

b.- Directly pressing **[ENTER]**:

- Select with keys **[▼]** or **[▲]** the desired parameter: *Vp-n*, *Vp-p*, *kVA*, *Hz*, *PF*, *kvarC*, *kvarL*, *kW* & *A*. Press **[ENTER]** to validate the choice.
- Set the scale offset (ZERO SCALE) with keys **[▼]**, **[▲]**, **[▶]**, **[◀]**, **[SET]** & press **[ENTER]** to validate the operation.
- Set the full-scale value (FULL SCALE) with keys **[▼]**, **[▲]**, **[▶]**, **[◀]**, **[SET]** & press **[ENTER]** to validate the operation.



### 5.2.3.- Oscilloscope

The display concurrently shows the wave forms of voltage and current of each phase (L1, L2 & L3).

#### 5.2.3.1.- Three phases: Voltage - Current.

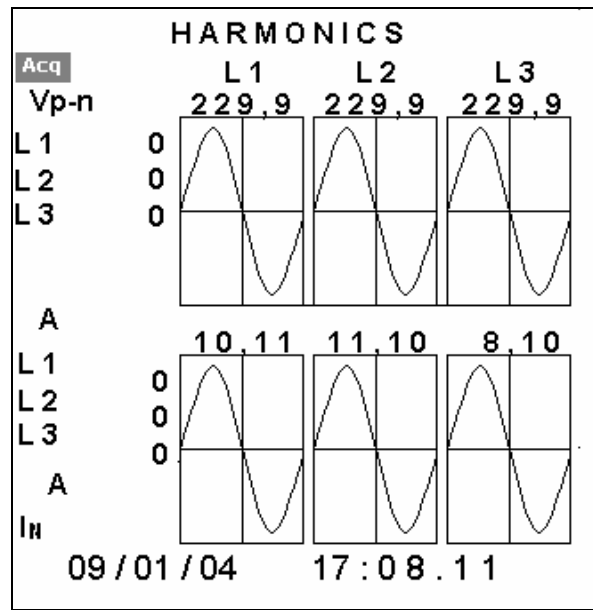

- Both the voltage and the current waveforms of the captured cycle are shown on the screen together with their respective effective values.
- With **[^]** & **[v]** keys select the operation to be carried out. After pressing the **[ENTER]** key the reverse video mode text indicates that one of the following operation will be carried out:
  - “Acq” : a new waveform is acquired.
  - “L1”, “L2” o “L3” : zoom on the waveform of the selected phase.
  - “I<sub>N</sub>” : zoom on the waveform of the neutral current. (only in AR5-L model)
- With the **[>]** & **[<]** keys you can move along the ordinate axis, and see the instantaneous voltage and current.
- With the **[ESC]** key the Setup menu is shown.

5.2.3.2.- Zoom.

This window shows the captured signal in detail.

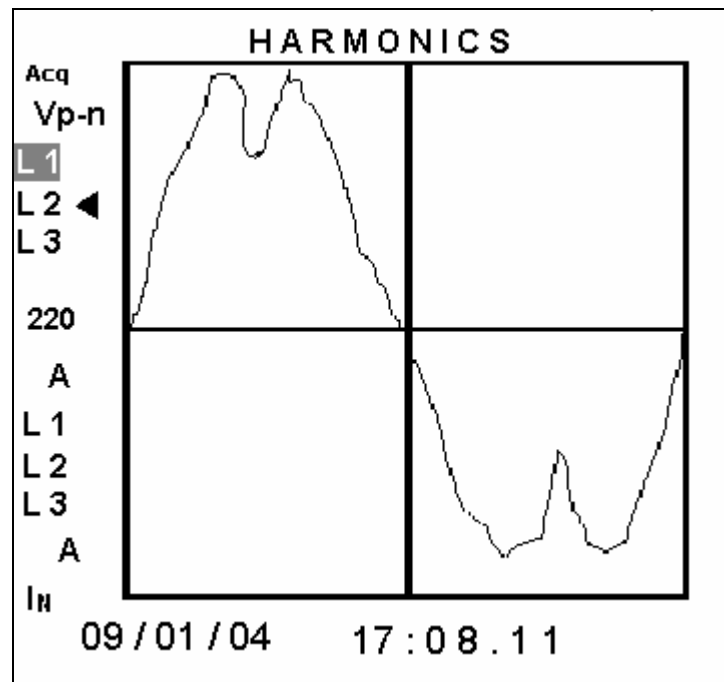

- The ◀ sign, indicates the kind of signal and the phase of the waveform that is being zoomed.
- Again, with the [▶] & [◀] keys you can move along the ordinate axis, and see the instantaneous voltage and current.
- With [▲] & [▼] keys select the operation to be carried out. After pressing the [ENTER] key the reverse video mode text indicates that one of the following operation will be carried out:
  - “Adq” : a new waveform is acquired.
  - “L1”, “L2” o “L3” : zoom on the waveform of the selected phase.
  - “I<sub>N</sub>” : zoom on the waveform of the neutral current. (only in AR5-L model)
  - If the selected phase is marked with the ◀ sign, you will next see the overall harmonic factorization of the selected signal
- With the [ESC] key the Setup menu is shown.

5.2.3.3.- Harmonic factorization.

The network analyzer has one screen where you can see the harmonic factorization of the signal that has been captured.

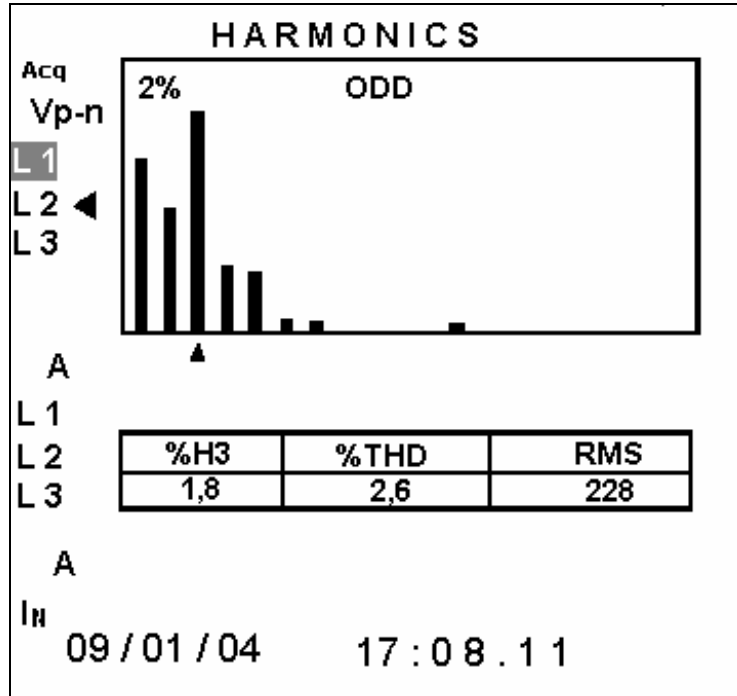

- The ◀ sign, indicates the kind of signal and the phase of the waveform that is being zoomed.
- With the [▶] & [◀] keys you can move the ▲ arrow along the ordinate axis and in the table below it the magnitude of the corresponding harmonic is shown.
- With [▲] & [▼] keys select the operation to be carried out. After pressing the [ENTER] key the reverse video mode text indicates that one of the following operation will be carried out:
  - “Acq” : a new waveform is acquired.
  - “ODD” or “EVEN” : it allows you for switching between even or odd harmonics.
  - “L1”, “L2” o “L3” : it carries out the harmonic factorization of the selected phase
  - “I<sub>N</sub>” : zoom on the waveform of the neutral current. (only in AR5-L model)
  - If the selected phase is marked with the ◀ sign, the next screen to be shown is the initial one in which the voltage and current of the three phases are shown (see section 5.2.1.-).
- With the [ESC] key the Setup menu is shown.

- Voltage and current harmonic content.

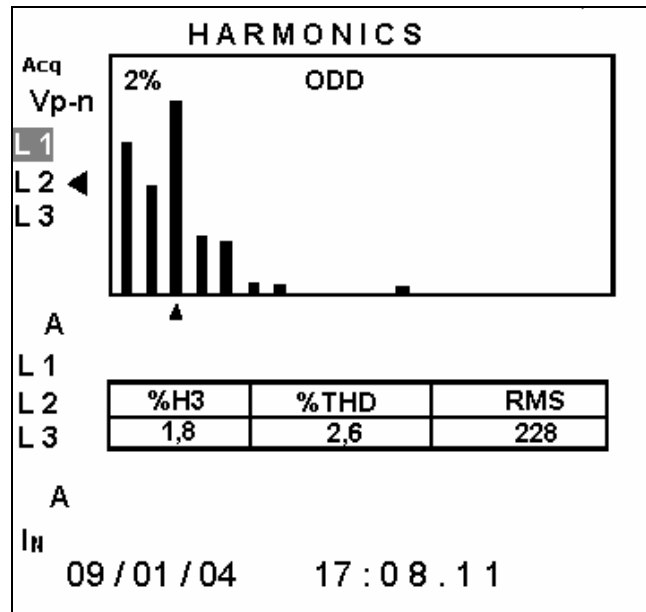

Where:

- %Hx : stands for the amplitude % of the selected harmonic referred to the fundamental.
- %THD : stands for the % of harmonic content referred to the fundamental
- RMS : stands for the signal true RMS value
- **Neutral current harmonic content.**(only in AR5-L model)

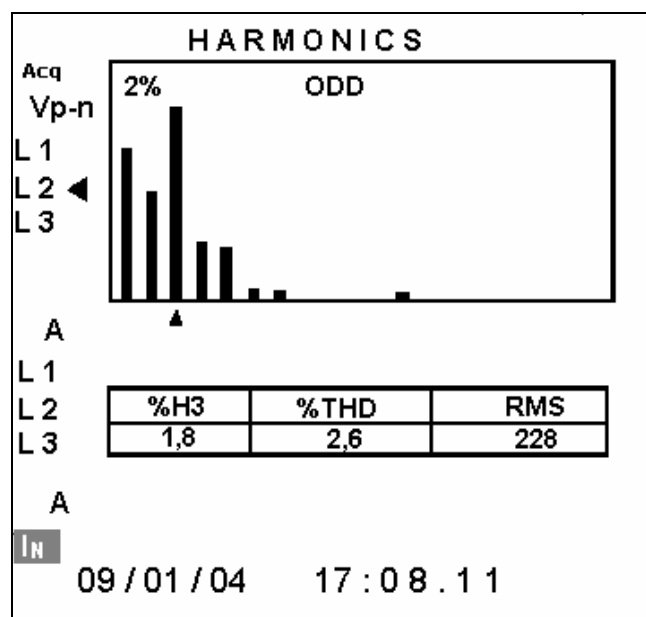

Where:

- %Hx : stands for the amplitude % of the selected harmonic referred to the RMS value.
- %THD : stands for the % of harmonic content referred to the RMS value.
- RMS : stands for the signal true RMS value.

### 5.2.4.- Setup visualization





This screen permits to check all Setup parameters in the analyzer.

The screen on the left is the one shown on the analyzer's display. The screen on the right explains the meaning of each term.

HARMONICS		HARMONICS	
SETUP		SETUP	
Measure: 3 $\Phi$ wire 1/1V 1000A - I <sub>N</sub> =100A		Type of measuring circuit V.T. ratio C.T. ratio/Neutral C.T.	
File: Std-prog.STD 00:15:00 Harm. 50 Cyclical RT xd :xh :xm :xms		Name and type of file Recording period Harmonics Memory type Time of register	
Trigger: Auto 0 0 00/00/92 00:00:00 00/00/92 00:00:00		Trigger parameter Max. Value Min. Value Trigger: date On Trigger: date Off	
Com: 9600/ NO /8/1		Communication parameters	
25/10/03 7:31:29		Preset date	

### 5.3.- Warning messages

Some warning messages can appear at the visualization screens. These messages inform about the ANALYZER performance:

- **STOP:** The analyzer is not recording data.
- **RECORD:** The analyzer is recording data.
- **TRIG?:** Trigger conditions are not met. No data is being recorded.
- **M. Full:** Memory is full.
- **M.Error:** There is an error in the memory. The memory must be formatted.
-  Analyzer battery charge status. When only the symbol ◀ is shown, it means that the battery is very low and the analyzer might turn off at any moment.
-  The battery is charging. The user can also see the accumulated battery charge level.
-  Full battery charge.
- **WARNING MAX 500 V** : The maximum allowable phase to neutral voltage of 500 V has been exceeded during the measuring process. When measuring phase-to-phase voltages the limit is set at 866 V.

## 6.- PROGRAMMING THE ANALYZER

To accessing ANALYZER setup options press the key **[SET]**. The analyzer will then inquiry for a password that consists of a key sequence to be pressed (the user has 15 seconds to press this sequence). If the default password has not been modified, then the following key sequence must be followed:

<b>PASSWORD</b>
<b>[◀] [SET] [▲] [SET]</b>

Standard Password

Once this password is entered, the analyzer will permit the user to modify any Setup parameters.

All programs have an independent setup, therefore, the setup must be always check to ensure a proper operation, since any modification will only affect the active operation program.

Diverse setting MENUS are available:

<b>SETUP</b> <b>DISPLAY</b> <b>RUN</b> <b>FILES</b> <b>CLEAR</b> <b>OFF</b> <b>LANGUAGE</b>
---

➔ INITIAL MENU

- Select one option with keys **[▼]** & **[▲]**.
- To access any menu option use **[▶]** or **[ENTER]**.
- To close the menu press **[◀]** or **[ESC]**. If this key is used when only the main menu is open, this is closed. If any modification over any setup parameter was done, before closing a confirmation of setup change is requested on display.

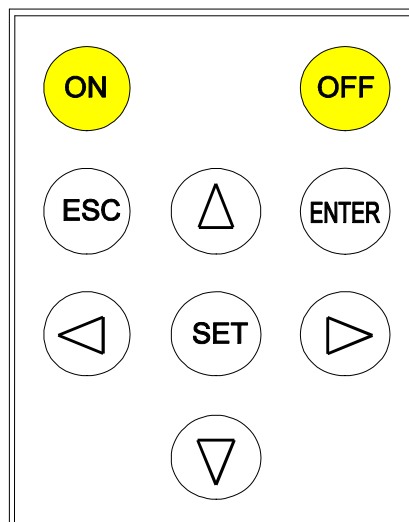

**6.1.- SETUP menu**

The analyzer can be user-configured to different performances involving its data analysis and recording modes, as it is followed shown:

<b>SETUP</b>
MEASURE
RECORD
COMM
CLOCK
PASSWORD
RECALL

➔ SETUP menu.

<b>MEASURE</b>
WIRING
PT/CT

4 wires / 3 wires / Aron / Single-phase / Bi-phase.  
V and A transformation ratios.

<b>RECORD</b>
PERIOD
TRIGGER
NAME
PARAM

hh:mm:ss ( 1 s to 4 h ).  
Level, Time, Off.  
File name ( 8 characters) and memory type.  
Special file parameters.

<b>COMM</b>
-------------

Baud / Parity / Bits / Stop bits.

<b>CLOCK</b>
--------------

DD/MM/YY hh:mm:ss.

<b>PASSWORD</b>
-----------------

Setting the analyzer password

<b>RECALL</b>
---------------

Standard.  
Recall Setup sure <yes > <no>.

### 6.1.1.- MEASURE

Use this option to set measuring conditions: **CONNECTION MODE SETTING ( 3 or 4 wires, Aron, single-phase or bi-phase) and VOLTAGE and CURRENT TRANSFORMATION RATIOS SETTING.**

<b>MEASURE :</b>	
WIRING	3Φ 3 Wires, 3Φ 4 Wires, 3PT–2CT, 1Φ y 1Φ Split..
PT / CT	Prim. V, Second. V, Prim. I

#### 6.1.1.1.- WIRING: Circuit type

Choice of the circuit type to be analyzed (rotary input).

- 3Φ 4 Wires: To measure Three-phase systems with Neutral wire. (only in AR5-L model)
- 3Φ 3 Wires: To measure Three-phase systems with Neutral wire. For this arrangement 3 current clamps must be used.
- 3PT-2CT: To measure Three-phase systems with Neutral wire. For this arrangement **only** 2 current clamps must be used.
- 1Φ: To measure Single-phase systems.
- 1Φ Split: To measure Bi-phase systems, composed by 2 Phases and the Neutral wire. (only in AR5-L model)

**Always that the measuring circuit type is modified, parameters selected to be recorded must be checked.**

#### 6.1.1.2.- PT/CT : Transformation ratios

Voltage and current transformation ratios setting. The program will sequentially inquire for following data:

- PRIM. V: Voltage transformer primary value.
- SEC. V: Voltage transformer secondary value.
- PRIM. I: Current transformer primary / Current clamp primary, used for measuring the line currents.
- PRIM. I<sub>N</sub>: Current transformer primary / Current clamp primary, used for measuring the neutral current. (only in AR5-L model)

**NOTE 1 :** *If voltage is directly measured (no voltage transformer is used), you must set PRIM.V = 1/SECV.V = 1.*

**NOTE 2 :** *PRIM. I & PRIM I<sub>N</sub> --> This option permits to program:*

- a) *The ratio of the Current clamp to be used.*
- b) *In case of a high voltage system, the measurement will be carried out through the secondary of current transformers. A shunt ATS-III 5 A a.c./ 2 V a.c. or CP5 clamp will be then required to enter the measurement signal into the analyzer (Never directly connect the 5 A signal to the analyzer.). For this case, the C.T. primary must be set at the primary value of the C.T. used for measuring purposes.*

*Ratio set must be modified for each Current or transformer type change to avoid measurement mistakes. Standard clamps give a voltage output (generally 2 a.c. at full-scale).*

**NOTE :** *Secondary is always set at 2 V a.c. (it is not user-programmable).*

### 6.1.2.- RECORD menu



The recording conditions are here user-programmed:

<b>RECORD</b>	
PERIOD	hh:mm:ss ( 1 s to 4 h ).
TRIGGER	LEVEL, TIME, OFF.
NAME	File name (8 characters) and memory type.
PARAM	Parameters stored by the analyzer when selecting an STD file

#### 6.1.2.1.- PERIOD: recording period

All values measured by the analyzer can be periodically saved in memory. The recording period (time period between each record) is user-definable.

Each record consists of the average values measured during the pre-defined period. This recording period can be from 5 s to 4 h

***j NOTE!** If a period longer than 4 hours is programmed, the display will show an error message during some seconds:*

*" xx:xx OUT OF RANGE "*

### 6.1.2.2.- TRIGGER: Trigger conditions

<b>TRIGGER</b>
LEVEL
TIME
OFF

You can program here certain conditions (Trigger) so that values are saved in memory only when these conditions are met.

Two types of trigger conditions are available:

- 1) Time trigger (TIME): DATE/TIME of ON (starting measurement process), &/or OFF (ending measurement process).
- 2) Parameter trigger (LEVEL): you can set a **maximum** threshold (measured values must be higher) &/or a **minimum** (measured values must be lower) that define the value range within the recording actions are performed (thus, for instance, the voltage to be higher than a certain level, or the current lower than another one, etc.).
- 3) OFF: Use this option to cancel all data programmed at former options.

If the defined trigger conditions are met, the analyzer stores data to its internal memory (STORE ON); and, on the contrary, no information is stored to memory (STORE OFF) and the display will show the message *TRIG?*.

- **LEVEL:**

Lets to set the trigger for a parameter, as well as its maximum and minimum range-limiting values.

- **PARAM:** Choice of the parameter for the trigger condition: (rotary input).
  - Select with keys [▼] or [▲] the desired parameter:  
Vp-p, Vp-n, A, kW, kvarL, kvarC, PF, Hz, kVA, Auto (None).
  - [ENTER] to validate the choice. ([ESC] to exit with no modification)
- **MAX:** Set here the maximum threshold: (numeric input).
  - Select with keys [▼], [▲], [▶] or [◀] the desired value and press [SET] to validate each figure.
  - Select “←“ on display + [SET] to delete a figure.
  - [ENTER] to validate the total value or [ESC] to exit with no modification.
- **MIN:** Set here the minimum threshold: (numeric input).
  - Select with keys [▼], [▲], [▶] or [◀] the desired value and press [SET] to validate each figure.
  - Select “←“ on display + [SET] to delete a figure.
  - [ENTER] to validate the total value or [ESC] to exit with no modification.

**Note:** the set value will be valid only if a trigger parameter was previously defined.

**POINTS TO CONSIDER:**

- If the selected parameter is voltage, current or any power:



- **TIME OFF:** When selecting this option the present OFF conditions are shown on display; and the procedure is equal to the above one.

TIME .OFF 00 /00 /00 00 :00 : 00
-------------------------------------

day/month/year hour:minute:second

**POINTS TO CONSIDER:**

- a) *To void the time TRIGGER, all values must be zero.*
- b) *If only the ON & OFF TIME are programmed (two DATES set to zero), the defined time period will be cyclically repeated by the analyzer.*

**ADDITIONAL NOTES:**

- a) The analyzer will save data in memory only when both TRIGGER conditions are met: Time (ON-OFF) and Parameter (maximum and minimum). If any condition is not met, no value is stored to memory (STORE OFF state). In case that trigger conditions are void (ON & OFF set to zero, and parameter set to AUTO), all values will be saved in memory according to the previously defined recording period.
- b) If trigger conditions are met at any moment within the defined recording period, the average values for the whole period will be saved in memory.

### 6.1.2.3.- NAME: recording file name

File name setting (8 characters, with no extension) and file type setting (Cyclical – Linear).

- **File name.**

NAME STD-PROG
------------------

- Pressing **[ENTER]**: Text on display is directly validated.
- **To modify:** (alphanumeric input).
- Select with keys **[▼]**, **[▲]**, **[▶]** or **[◀]** the character to modify and press **[SET]** to validate each character.
- Select “**←**” on display + **[SET]** to delete a character.
- **[ENTER]** to validate the total text or **[ESC]** to exit with no modification.

### NOTES!

a) If the typed name already exists in memory, when exiting setting actions, the display will show:

“Overwrite file Sure? “ --> Do you really overwrite the file?

- If yes is answered, the previous file is deleted.
- If no is answered, setup menu is not exited, thus a new name can be typed for the file, or the setting actions can be cancelled.

- **File type.**

Choice of the file type for data recording purposes:

- Cyclical: Cyclical/rotary memory (FIFO). When this file type is selected, only one file can be simultaneously used.
- Linear: Linear memory. Once the memory is full, no more new data is recorded by the analyzer.

<b>Linear and cyclical files are not compatible between them.</b>
---

<b>The memory cannot simultaneously contain files of both types.</b>
--

<b>In case of a cyclical file, all the memory will be used by this file. No memory can be allocated to another file.</b>
--

If the type of file is changed, the memory will have to be formatted when exiting setup.

#### 6.1.2.4.- PARAM: Choosing the parameters to be saved

As said before, parameters to be saved in memory are user-definable when working with STD files.

- Pressing **[ENTER]** previously user-defined parameters are automatically validated.

#### - **To modify:**

- Place over the desired parameter with keys **[▼]**, **[▲]**, **[▶]** or **[◀]**.
- Pressing **[SET]** the state of the parameter switches. Parameters to be saved are on a black background, and the ones to be not save are on a white background.
- Placing over the text Inst (Instantaneous values) and pressing **[SET]**, you can now select the maximum values to be saved (MAX).
- Placing over the text Max (Maximum values) and pressing **[SET]**, you can now select the minimum values to be saved (MIN).
- Placing over the text MIN (Minimum values) and pressing **[SET]**, you can now select the parameters of harmonics that will be kept. Including the number of harmonics(30 or 50), V and I for each phase and neutral current (only in AR5-L model)
- Press **[ENTER]** to validate the choice or **[ESC]** to exit with no modification.

#### **Note:**

- In case that have been selected some not-compatible parameters with the active measuring circuit, when exiting Setup, analyzer will warn the user about this fact and will automatically unselect such wrong parameters.
- If values the parameters to be stored are changed, when exiting setting actions, the display will show:

“Error: New file should be created”

This message is shown since the change of parameters in an already existing file is not allowed. Follow these instructions to change the parameters of a file:

1. If you want to keep the file name.
  - Stop analyzer data recording process: SET -> RUN -> Stop.
  - Exit SETUP.
  - Delete the existing file: SET -> FILES -> DELETE.
  - Modify the parameters to be saved: SET -> RECORD -> PARAM
  - Enable the analyzer data recording process: SET -> RUN -> Run
  - Exit SETUP.
2. If you want to change the file name.
  - Change the file name: SET -> RECORD -> NAME.
  - Modify the parameters to be saved: SET -> RECORD -> PARAM
  - Exit SETUP.

### 6.1.3.- COMM: Communication parameters

Program here the parameters of the built-in RS-232 serial output. When selecting this option the present parameters are shown on display:

COMM			
9600	NO	8	1

Baud / Parity / Length / Stop bits

- Pressing **[ENTER]**: values on display are directly validated.
- **To modify:** (rotary input).
- Select with keys **[▶]** or **[◀]** the position to modify.
- Though keys **[▼]**, **[▲]** the value of the selected position is increased or decreased.
- **[ENTER]** to validate the total value or **[ESC]** to exit with no modification.

### 6.1.4.- CLOCK: Internal clock

Use this section to set the analyzer internal clock in time: date / time and displaying format.

When this option is selected, presently programmed values are shown by display:

CLOCK TYPE	
DD /MM/YY	HH :MM:SS

CLOCK TYPE	
MM/DD/YY	HH :MM:SS

After validating the date format, the present date and time will be displayed according to the selected arrangement:

CLOCK	
00 /00 /00	00 :00 : 00

Proceed similarly than for the former section.

**6.1.5.- PASSWORD: Safety setting.**

Set here the analyzer password configuration. This password will be required to access the Setup menu. Thus, the manipulation of the analyzer by not-authorized people can be avoided.

The password can be also required for turning the analyzer off.

The default password is:

<b>PASSWORD</b>
[◀] [SET] [▲] [SET]

**Change of Setup access password:**

Firstly enter the old password:

OLD PASSWORD * * * *
-------------------------

Then enter the new password:

NEW PASSWORD * * * *
-------------------------

Finally, confirm the new password:

CHECK PASSWORD * * * *
---------------------------

During this password modification process, the following error messages can be shown in screen during 5 s:

Incorrect Old password	Wrong password
Incorrect Check password	The confirmation of the new password has failed

**Turning the analyzer off when the password is enabled:**

To avoid the analyzer to be accidentally turn off, or by not-authorized persons, an optional password can be enabled to be inquired when the analyzer is turn off.

The procedure to follow when this password is enabled is:

- 1) Press the key **[OFF]** during 5 seconds.
- 2) You will see in display:

<b>PASSWORD</b>

- 3) Enter the correct Password.
- 4) Press **[OFF]** again

The analyzer will turn off if the entered password is the correct one.



### 6.1.6.- RECALL: Read configuration

You can here recall a **standard** configuration.

Set Standard..  
 sure?  
 <yes > <no>

- A confirmation is requested: "Recall Setup sure <yes> or <no>". With keys [▶] & [◀] select yes or no, and then press [ENTER].

A "**Standard**" operation program for the analyzer is available to be user-recalled. Its features are:

- V.T. ratio (SET + V) : 1 / 1
- Current ratio : 1000 A
- Neutral current ratio : 100 A
- Measuring circuit : 3Φ 4 Wires .
- Period (SET + PERIOD) : 15 minutes
- TRIGGERS (Time and parameter) : All set to zero
- File name (FILE Name) : STD-PROG -- Linear
- Communication parameters : 9600, No, 8, 1
- RUN : RUN
- Password : [◀] [SET] [▲] [SET]
- Password for turning the analyzer off : NO

## 6.2.- DISPLAY menu

DISPLAY	
BAR GR.	Bar graphs
EXPAND	Expanded Param. (3 parameters).
CONTRAST	Contrast
ANGLE	$\cos\phi$ or P.F

You can at this point define the options about the parameters to be visualized on display, the graphic mode performance, ...

### 6.2.1.- BAR.GR.

To determine the parameter to be graphically displayed, in addition with its scaling. Both maximum and minimum values of the graph are inquired for auto-scaling performance.

- Choice with keys [ $\blacktriangledown$ ] or [ $\blacktriangle$ ].
- [**ENTER**] to validate selection or [**ESC**] to exit with no modification.

### 6.2.2.- EXPAND

To choose three instantaneous parameters to be bigger size displayed for a clearer reading.

- Select with keys [ $\blacktriangledown$ ], [ $\blacktriangle$ ], [ $\blacktriangleright$ ] or [ $\blacktriangleleft$ ] the desired parameter, and enable or disable each one with the key [**SET**].
- Select "CLEAR ALL " on display + [**SET**] to clear all parameters.
- [**ENTER**] to validate the choice or [**ESC**] to exit with no modification.

### 6.2.3.- CONTRAST: Screen contrast

The user can here vary the contrast of the analyzer's display:

- With the [ $\blacktriangleright$ ] you can intensify the display contrast and with the key [ $\blacktriangleleft$ ] this can be lowered:

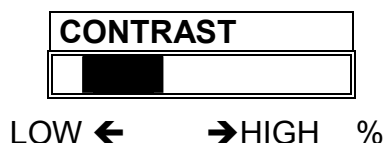

**6.2.4.- ANGLE**

To choose the parameter to be displayed between  $\cos\phi$  or P.F (power factor)

**NOTE:** It's not allow to save  $\cos\phi$  data in memory. Only can be read on display.

**6.3.- RUN: data recording process status**

You can here enable or disable the data collection and logging action in the analyzer.



- With keys [▼], [▲] RUN or STOP is selected.
- [ENTER] to validate or [ESC] to exit with no modification.

**6.4.- FILES Menu**

Non-volatile analyzer internal memory is storing data up to its maximum capacity. Once full, neither new data will not be saved in, nor stored data will be lost (provided no incorrect operation is done).

When memory is full, the display will show: **"MEMORY FULL"**.

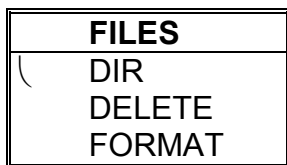

☞ FILES MENU

**6.4.1.- DIR: Directory**

This option shows on display a directory of all files saved in memory.

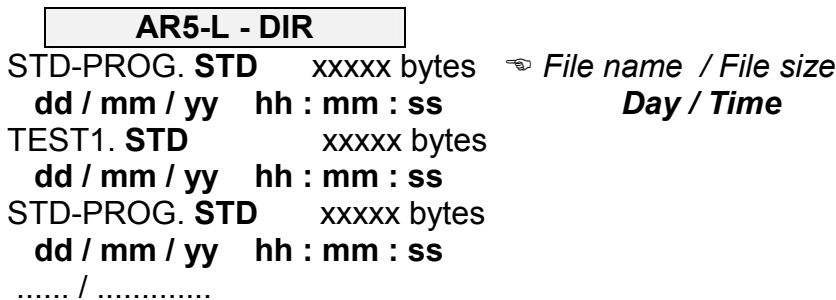

**Free bytes:** xxxxxxxxxx ☞ Number of free bytes in memory

- Keys [▼] or [▲] allows reading more files in case that all files stored by the analyzer cannot be shown in only one screen.
- Keys [ENTER] or [ESC] to exit.

**6.4.2.- DELETE: Deleting a file**

You can here delete any file from the internal memory.

<b>DELETE</b>		
STD-PROG. <b>STD</b>	xxxxx bytes	☞ <i>File name / File size</i>
TEST1. <b>STD</b>	xxxxx bytes	
STD-PROG. <b>STD</b>	xxxxx bytes	
.....		

- With keys [▼] & [▲] select the file to be deleted.
- **[ENTER]** to confirm selected file erasing. Once press, a confirmation is required.
- Press key **[ESC]** to exit with no modification.

### 6.4.3.- **FORMAT: Formatting the analyzer internal memory**

This option lets the user to format the internal memory.

<b>FORMAT</b>
---------------

Once the format action over the internal memory is confirmed, a confirmation is required. Take into account that this action will mean all stored data to be deleted.

**Note:** Do not turn the analyzer off during the memory format process, otherwise the display will show an error message and the process should be redone.

### 6.5.- **CLEAR menu: Deleting data**

<b>CLEAR</b>	☞ DATA CLEARING MENU
ENERGY	Erasing energy counters
MAX/MIN	Erasing maximum and minimum values

#### **ENERGY :**

The analyzer has several energy counters, which keeps their values even though the analyzer is powered off.

The ENERGY options lets the user to reset these counters to zero.

#### **MAX/MIN:**

The analyzer records in memory the maximum and minimum values of measured values. These values are kept in memory even though the analyzer is powered off.

Options MAX/MIN lets the user to clear maximum and minimum values.

### 6.6.- Menu OFF: Enable / Disable Password.

In order to avoid an accidental manipulation of the analyzer, the analyzer can be set to request for a password when the user wants to turn it off.

<b>Password?</b>	
<b>&lt;Yes&gt;</b>	<b>&lt;No&gt;</b>

- With the key [▶],[◀] you can select:
  - YES: A password is requested to turn the analyzer off.
  - NO: No password is required to turn the analyzer off.
- [ENTER] to validate the choice or [ESC] to exit with no modification.

### 6.7.- Menu LANGUAGE

It allows to select the language in which the menus will be presented.

<b>Language</b>
<b>English</b>

- With keys [▼] & [▲] select the language.
  - [ENTER] to confirm selected language
- Press key [ESC] to exit with no modification.

*NOTE: This configuration is commune for all the programs.*

## 7.- ANALYZER COMMUNICATIONS

To connection to PC of the analyzer must be done through the power supplier set, which will be necessary connected to the main. Perform the connection using the two wires factory-delivered with the analyzer.

One cable will link the analyzer to the power supplier set, and another cable is a standard RS232 connector.

When starting communication tasks take into account:

- Communication parameters of the analyzer and the PC must fully coincide.
- The power supplier set must be plugged into.
- The analyzer cannot be into the setup menu.

CIRCUTOR has a software package that permits the user to retrieve stored data in the analyzer to PC for a further complete analysis.

## 8.- TECHNICAL SPECIFICATIONS

### Supply voltage:

Through an external power supplier set 100 V a.c. – 240 V a.c.

Battery: 5VHAA 1200 (Ni-MH)

Frequency : 50...60 Hz

Burden : 15 VA

Operation temperature : 0 / 40 °C

Altitude: ≤ 2000

Maximum relative humidity 85 % (no condensation)

Measuring circuit : Three (3 or 4 wires), ARON, single-phase and bi-phase

Safety : Category III - 600 V, as per EN 61010

Pollution degree 2

Indoor use

### Voltage measurement:

Measuring range : 20 to 500 V a.c. (phase-neutral) CAT III  
automatic scale adjustment

Other voltages : through suitable voltage transformers

Frequency : 45 to 65 Hz

### Current measurement:

Measuring range: see available current clamps

Current transducer ratio : user-programmable

Measurement units : automatic scale adjustment

Built-in clock with rechargeable battery: Date and time

Display : LCD; 160 x 160 pixels (Back-light)

RS-232 output : serial type output

Internal memory : 1 Mb

### Accuracy class:

Voltage ..... 0.5 % of readout ± 2 digits

Current ..... 0.5 % of readout ± 2 digits

Active power ..... 1.0 % of readout ± 2 digits

Reactive power..... 1.0 % of readout ± 2 digits

Measuring conditions to assure accuracy class:

- Errors due to voltage and current transformer not included

- Temperature range : 5 °C to 45 °C

- Power factor : 0.5 to 1

- Measuring range : between 5 % and 100 %

### MECHANICAL CHARACTERISTICS

Case : Portable case.

Dimensions : 220 x 60 x 130 mm

Connection terminals : input/output terminals

Keyboard/ display : in frontal panel

Weight: 0,8 kg.

---

**POWER SUPPLIER SET**

80 V a.c. – 265 V a.c. / 12 V d.c.

CAT III: 85 – 225 V a.c.

CAT II : 225 – 265 V a.c.

**RELEVANT STANDARDS**

EN 60664, EN 61010, EN 61036, VDE 110, UL 94

---

**EM EMISSION.**

- EN 61000-3-2 (1995), Harmonics.
- EN 61000-3-3 (1995), Voltage variations.
- EN 50081-2 (1993), Industrial emission:
  - EN 55011 (1994): Conducted (EN 55022 - Class B).
  - EN 55011 (1994): Radiated (EN 55022 - Class A).

**EM IMMUNITY.**

- EN 50082-2 (1995), Industrial immunity.
  - EN 61000-4-2 (1995), ESD.
  - ENV 50140 (1993), EM Radiated field of RF.
  - EN 61000-4-4 (1995), EFT burst.
  - ENV 50141 (1993), RF common mode.
  - EN 61000-4-8 (1995), 50 Hz H-field.
- EN 50082-1 (1997), Residential Immunity.
  - EN 61000-4-5 (1995), Surges.
  - EN 61000-4-11 (1994), Dips, Interruptions.

**(as shown in the test report reference number: 08077IEM.002)**

---

**CASE SYMBOLS:**

: Warning. Maximum allowable input voltage: 500 V



: Reinforced isolation



These products have been designed and manufactured with top quality components and they can be recycled and reused.

Electrical and electronic products contain substances that can harm the environment if they are not adequately treated.

This symbol means that electrical and electronic equipment should not be thrown with other household appliances at the end of its useful life.

Please take the obsolete products being replaced to a waste collection point or contact your local administration.

The European Union has established specific collection systems for electronic and electrical equipment waste.

Please help us preserve the environment!

Register Number REI-RAEE (ES): 3338

**ACCESSORIES**

- AR5 and AR5-L Programs
  - FLICKER .....CODE. M 80223
  - DISTORTIONS .....CODE. M 80224
  - CHECK-METER .....CODE. M 80225
  - FAST CHECK .....CODE. M 80226
  - LEAK.....CODE. M 80229
  - FILE-VISION.....CODE. M 8022A
  - Software POWERVISION...Visit our web site
- Current measurement:
  - a) Through Current clamps (3 Clamps KIT):
    - “ CP-2000-200 .....CODE M 81045
    - “ CPR-1000 ..... CODE M 81044
    - “ CPR-500 ..... CODE M 81043
    - “ CP-100 (M1-U) ..... CODE M 81042
    - “ CPR-100 (For Neutral current measurement)....CODE M 81036
    - “ CF-5 LEAK CLAMP .....CODE M 81331
    - “ CP-5 ..... CODE M 81041
  - b) Through flexible Current clamps (3 Clamps KIT):
    - “ C-FLEX 200/2000/ 20000 – Length 45 cm..... CODE M 81141
    - “ C-FLEX 200/2000/ 20000 – Length 80 cm..... CODE M 81142
    - “ C-FLEX 200/2000/ 20000 – Length 120 cm..... CODE M 81143
  - c) ATS-5 shunt (5 A / 2 V a.c.) + current transformers (./5 A) ....CODE M 89925
- Carrying case
  - Carrying case for AR5 and AR5-L current clamps..... .. CODE M 89921
  - Carrying case for AR5-L and AR5..... CODE M 89901
  - 1000 case (with protection rubber CPR-1000) ..... CODE M 89923
  - 2000 case (with protection rubber CPR-2000) ..... CODE M 89924

**9.- SAFETY WARNINGS**



The user should take into account all installation instructions referred in sections INSTALLATION AND START-UP, CONNECTION INSTRUCTIONS and TECHNICAL SPECIFICATIONS of the analyzer.

Note that with the instrument powered on, the terminals could be dangerous to touching, and cover opening or elements removal actions may allow accessing dangerous parts. The analyzer has been designed and tested to meet IEC 348 standard and is factory-shipped in proper conditions.



**10.- MAINTENANCE**

The analyzer does not require any special maintenance. No adjustment, maintenance or repairing actions should be done over the instrument open and, should those are essential, high-qualified operators must perform them. Spares should be provided by manufacturer.

The batteries are rechargeable and should be provided by manufacturer

Before any adjustment, replacement, maintenance or repairing operation is carried out, the instrument must be disconnected from any power supply source.

When any protection failure is suspected to exist, the instrument must be immediately put out of service.

The own instrument design permits a quick replacement in case of damage.

**NOTE:** Occasionally clean the equipment with water and detergent using a soft, damp cloth. Do not use abrasives or solvents. Completely dry the equipment before using it again.

**11.- CHANGING THE BATTERY**

It is possible to change the battery with a simple and easy way. The battery is placed in rear part of the analyzer.



Before opening the cover to disconnect all the connections of tension and current

In order to change the battery, do the following steps.

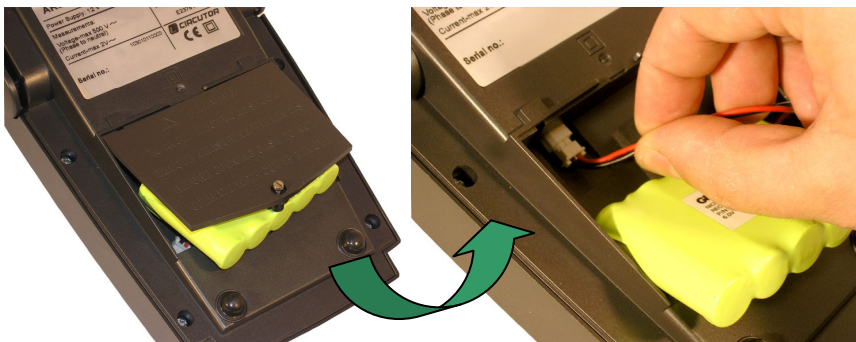

1. Remove the cover
2. Unplug the battery
3. Replace the battery (the single connector enters a position, not to force)
4. Place the cover

If you want to request a battery for replace the code it is M89904.

**12.- TECHNICAL SERVICE**

For any inquiry about the instrument operation mode or in case of malfunction, you can contact CIRCUTOR's technical service.

CIRCUTOR S.A. - Aftersales Service  
Vial Sant Jordi, s/n  
08232 – Viladecavalls (SPAIN)  
Tel: (+34) 93 745 29 00  
Fax: (+34) 93 745 29 14  
e-mail: [sat@circutor.es](mailto:sat@circutor.es)

**A. CABLE ARRANGEMENT**

Different cables used with the analyzer have following arrangements:

- Communication cable RS232: PC - Power supplier set

PC	POWER SUPPLIER SET
2	3
3	2
5	5
7	8
8	7

- Power supply/Communication: Power supplier set - analyzer.

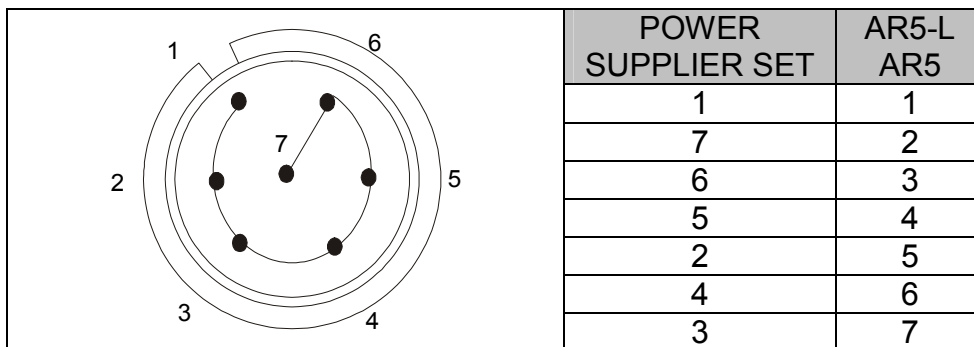

**B. QUICK GUIDE**

Menu		Description		Options	Standard		
Setup	Measure	Circuit		Choice type of measuring circuit.	3 wires 4 wires* Aron Single-phase Bi-phase*	4 wires	
		PT/CT	Transformation ratios of voltage and current measuring transformers	Rel. V	Voltage		Primary = 1 Secondary = 1
				Rel. A	Current		Primary = 1000
	Rel. A <sub>N</sub>			Neutral current		Primary = 100	
	Record	Period		Recording time	1 s to 4 h	15 minutes	
		Trigger	Level	Parameter trigger and threshold setting	Auto	Auto	
					Vp-p; Vp-n A kW; kvarL; kvarC PF Hz kVA		
			Time	Time trigger setting	No	No	
			Off	Cancel trigger options.	Date On Date Off YES NO	NO	
		Name		Working file name Memory type	Linear Cyclical	STD-PROG Linear	
		Param		Parameters to be stored to a custom type file	All		
	Comm		Communication parameters setting			9600,n,8,1	
	Clock		Analyzer's date and time setting				
Password		Password change			[↓][SET] [↑][SET]		
Recall		Recalling a Standard configuration		Standard			
Display	Bar Gr.		Choice a parameter to be graphical displayed	Vp-n; Vp-p Hz PF kVA; kvarC; kvarL kW A	Vp-n		
	Expand		Choice three parameters to be displayed in a big size mode	Instantaneous	Vp-n kW A		
	Contrast		Contrast				
	Angle		cosφ or P.F				
Run		Enabling/Disabling data recording		Stop / Run	Run		
Files	Dir		Directory of stored files				
	Delete		Deleting a file				
	Format		Clearing all memory content				
Clear	Energy		Clearing energy counters				
	Max/Min		Clearing maximum and minimum values				
OFF	Request for a password to turn the analyzer off.		Yes No	No			
LANGUAGE	In order to choose the language with which it is wanted to work		English / Español				

\* Only in AR5-L models